



Stramit 



**STRAMIT
CONDECK HP[®]**
COMPOSITE SLAB SYSTEM

p r o d u c t t e c h n i c a l m a n u a l

conforms to
AS 3600-2009



STRAMIT CONDECK HP® COMPOSITE SLAB SYSTEM

Selection & Specification

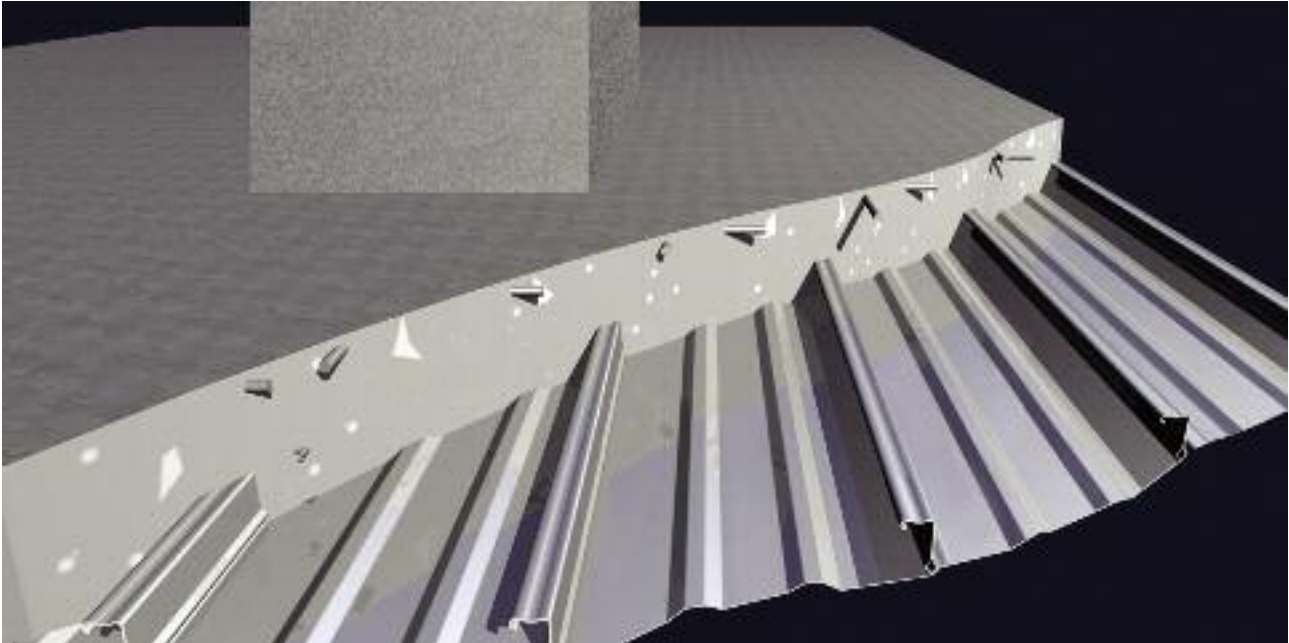

Introduction

This revised **Stramit Condeck HP®** Composite Decking Technical Manual contains the latest data for both concrete frame and steel frame construction.

Features of the **Stramit Condeck HP®** Composite Decking system include:

- **Stramit Condeck HP Plus™** End Span Enhancement Accessory for longer unpropped spans and greater design efficiency.
- Fire Design method that utilises the fully embedded portion of **Stramit Condeck HP®** Decking ribs to reduce Fire Emergency Reinforcement.
- Shear stud placement rules that permit almost unlimited versatility in the number and position of shear studs.
- The use of Partial Shear Connection Theory in line with latest industry best-practice.
- Increased galvanised coating thickness for even greater durability.

- **Condeck Shades™** with anti-glare coating for worker comfort and safety.
- Easy-to-use **Slab Designer™** software, that allows for variations in span lengths, live loadings, stacked material loadings and more.

Stramit continues to collaborate closely with organisations such as Standards Australia, BRANZ, CSIRO, The University of Sydney and The University of Western Sydney. This interaction ensures that Stramit is at the forefront of composite decking design.

Applications

Stramit Condeck HP® Composite Decking is ideal for floor slab construction in both steel frame and concrete frame construction, including band beam applications and post-tensioned slabs. While generally used in composite construction, **Stramit Condeck HP®** Decking also provides cost effective formwork in conventional slab applications.

IMPORTANT NOTE

The information contained within this brochure is for general use and information only. Before application in a particular situation, Stramit recommends that you obtain appropriate independent qualified expert advice confirming the suitability of product(s) and information in question for the application proposed. While Stramit accepts its legal obligations, be aware however that to the extent permitted by law, Stramit disclaims all liability (including liability for negligence) for all loss and damage resulting from the use of the information provided in this brochure.

CONTENTS

Selection and Specification 2-4

Introduction	2
Applications	2
How To Use	3
Software	4
Testing	4
Thickness/Mass	4
Materials	4
Engineering Specification	4
Adverse Conditions	4
Compatibility	4
Span Definition	4

Design 5

System Description	5
Design Overview	5
Design Example	5
Section Properties	5
Shear Studs	5
Cantilevered Balconies	5
Overhangs	5
Slab Properties	5

Formwork Mode Design 6-11

Propping Tables	6-11
Loading	6&9
Deflection Limits	6&9
Design Principles	6
Support Frame Types	6

Composite Slab Design 12-38

Composite Table Assumptions	12
Composite Span Tables	13
Contents	13
Tables 5-16	14-37
Loading	38
Design Principles	38
Other Cases	38
Shrinkage & Temperature Mesh	38
Negative Reinforcement	38
Crack Control For Flexure	38
Type 4 Shear Reinforcement	38

Fire Design 39-42

Design Principles	39
Slab Insulation Table	39
Fire Design	39
Detailing Precautions	39
Fire Design Procedure	39
Negative Reinforcement For Fire	40
Positive Reinforcement For Fire	41
FER Mesh Reduction	42
Design Example	42
Fire Resistant Sprays	42
Fire Resistant Ceilings	42

Procurement 43

Obtaining Prices	43
Components	43
Lengths	43
Orders	43
Lead Times	43
Related Products	43
Delivery/Unloading	43
Site Storage	43

Installation 43-47

Good Practice	43
Supports	43
Walking	43
Cutting	43
Temporary Propping	43
Decking Placement	44
Fixing	44
Side-Lap Fastening	44
Slab Edges	44
Wall Abutments	45
Large Slab Penetrations	45
Small Slab Penetrations	45
Stramit Condeck HP Plus™	46
Shear Studs	46
Stacked Materials	46
Sealing	46
Mesh Placement	46
Concrete Pouring	47
Admixtures	47
Concrete Curing	47
Prop Removal	47
Suspension Hangers	47

Additional Information 47

Technical Assistance	47
Further Information	47
Other Products	47

How To Use

This manual can be used in several different ways, for direct product selection, to enable detailed composite slab calculations, or as an adjunct to **Stramit Condeck HP®** Composite Slab design software.

For direct product selection – if fire is a consideration, and propping is acceptable:-

- Determine the minimum slab thickness from Table 18 on page 39.
- Then choose the most appropriate page of tables using the list of table criteria on page 13.
- For the desired span and slab thickness determine if the imposed live load limit is sufficient for the intended duty. Tables for each thickness of decking can be found on each page opening. Provide negative reinforcement for continuous slabs.
- The required propping is indicated on the composite graphs, but please check the full propping tables on pages 6-11. Finally determine the reinforcement requirements from Table 17 on page 38 and Table 20 on page 41.

For unpropped applications:-

- start with the propping tables on pages 6-7 or 9-10. (Note that the use of **Stramit Condeck HP Plus™** End Span Accessory increases unpropped spans.)

For detailed composite slab calculations – use the properties in Table 2 on page 5 or use the **Stramit Condeck HP®** Composite Slab design software which has a full audit trail printout option to assist with detailed computations.

Software

Stramit has software available for design of **Stramit Condeck HP®** Composite Slabs. **Stramit Condeck HP Slab Designer™** incorporates formwork, composite and fire design considerations, and allows for many more variables and permutations than this manual. Contact your nearest Stramit office to obtain a copy of the software CD ROM.

Testing

Recent research and development activity has involved testing at the Centre for Advanced Structural Engineering, University of Sydney, Centre for Construction Technology & Research at the University of Western Sydney and CSIRO. This has included tests related to fire design, composite action, shear studs, bare steel and deflection.

Thickness/Mass

Stramit Condeck HP® Decking is generally offered in three standard base metal thicknesses of 0.75mm, 0.90mm and 1.0mm. Other thicknesses may be supplied, dependent on lead times and availability. **Stramit Condeck HP Plus™** End Span Accessory is generally offered in 1.0mm base metal thickness.

Table 1

STRAMIT CONDECK HP® DECKING – Thickness/Mass						
Stramit Product	Thickness*		Mass – Z350		Mass – Z450	
	BMT (mm)	TCT (mm)	per unit area (kg/m ²)	per unit length (kg/m)	per unit area (kg/m ²)	per unit length (kg/m)
Condeck HP® decking	0.75	0.78	10.14	3.04	10.32	3.09
	0.90	0.93	12.04	3.62	12.22	3.67
	1.00	1.03	13.31	4.00	13.49	4.05
Condeck HP Plus™ accessory	1.00	1.03	3.6#	N/A	3.6#	N/A

* Base metal thickness (BMT) is used for structural design analysis, whilst total coated thickness (TCT) values are approximate and given for reference only.

Assumes use at every rib, but applies only over that length of the slab (usually end spans only) where utilised.

Materials

Stramit Condeck HP® Decking is manufactured from high-tensile (G550) steel with a Z350/Z450* galvanised coating, in full conformance with ASI 397. **Stramit Condeck HP Plus™** End Span Accessory is manufactured from high-tensile (G550) steel with a Z275 galvanised coating (please note that **Stramit Condeck HP Plus™** End Span Accessory is always fully embedded within the finished slab).

It is also possible to supply **Stramit Condeck HP®** Decking with the underside Colorbond coated. Supply would be subject to project size and lead-time.

* Z450 galvanised coated product can be supplied based on minimum order quantity and availability.

Engineering Specification

Maintaining the correct specification of composite decking is important to ensure that all design requirements are met. The following specification is recommended:

The concrete formwork shall be X.XXmm thick Stramit Condeck HP with 55mm high ribs spaced at 300mm centres. Material shall be G550 high-tensile steel in accordance with ASI 397, with a Z350/Z450 galvanised coating.

The manufacturer shall provide independently verified data and documentary evidence enabling fully embedded rib flanges to contribute to fire emergency reinforcement.

Shear studs are to be positioned strictly in accordance with the manufacturers recommendations for the nominal spacing specified.

Individual sheets shall be hinged into position in accordance with the manufacturers instructions. Prior to concrete pouring, foot traffic and other construction loads being applied, the Condeck HP shall be propped in accordance with the manufacturers propping table. Reinforcement and concrete placement shall be as directed by the engineer. All work is to be completed in a workmanlike manner and all dirt, mud, debris, screws, rivets, cuttings, etc are to be removed prior to concrete pouring. Props are not to be removed until authorised by the site engineer.

Adverse Conditions

Stramit Condeck HP® Decking has excellent durability. However, in applications close to marine or severe industrial environments, or closer than 450mm to the ground, please contact Stramit for a more detailed assessment of your needs, and for guidance on any precautions that may be required.

Compatibility

Direct contact between galvanised steel and copper, or water run-off from copper onto galvanised steel must be avoided, as premature corrosion will result.

Span Definition

Throughout this manual the spans referred to are Effective Spans. The effective span is the lesser of centre/centre distance between permanent supports and

- in the case of construction phase, clear span +55mm or
- in the case of composite phase, clear span + the depth of the slab

NOTE: a & b above apply only for stiff supports, e.g. concrete beams, steel I-beams etc.

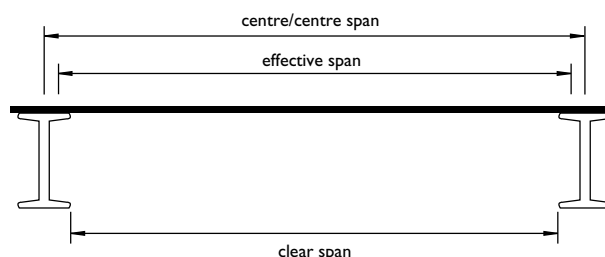

Span types within the manual reflect permanent supports only. A SINGLE span has 2 permanent supports. A DOUBLE span has 3 permanent supports. CONTINUOUS spans have 4 or more permanent supports.

DESIGN

System Description

The **Stramit Condeck HP®** Composite Slab System comprises of **Stramit Condeck HP®** Decking, **Stramit Condeck HP Plus™** End Span Accessory (where required), ceiling hangers, **Stramit Edgeforma™** and design information necessary for a fully integrated suspended slab.

Design Overview

Design of the suspended slab using the **Stramit Condeck HP®** Composite Slab System requires analysis of three separate functions:-

Formwork mode – including laying of the decking, propping (if required), concrete pouring and curing, and incidental use during this time such as stacked material loading.

Composite slab – end use performance for both strength and serviceability criteria such as long-term deflection. Includes interactive performance with support members such as concrete band beams or composite steel beams using shear studs.

Fire – where fire rating is required, determine the slab thickness and fire emergency reinforcement requirements. Can incorporate the intrinsic strength of fully embedded ribs in the fire resistance design.

Design Example

To view a detailed design example use the **Stramit Condeck HP Slab Designer™** software and invoke a full design printout for an example of your own choosing.

Section Properties

Section properties for **Stramit Condeck HP®** Decking and Composite Slabs are based on AS3600 and comprehensive testing.

Shear Studs

When used in conjunction with steel beams, **Stramit Condeck HP®** Decking offers the advantage of being particularly suitable for use with shear studs. The use of shear studs enables the design of highly efficient composite beams.

Stramit Condeck HP® Decking offers tremendous versatility in the number and placement of shear studs, due to its fully embedded ribs. Up to 20 studs per metre width are possible when used in a double row, or 10 studs per metre width in a single row along the beam. Standard placements for 19mm diameter studs, along with placement rules are given on page 46 of this manual.

Table 2

STRAMIT CONDECK HP® DECKING – Deck Section Properties (per metre width)							
thickness - BMT (mm)	mass (kg/m ²)*	cross sectional area (mm ²)	Y _{cg} (mm)	total section I (10 ⁶ mm ⁴)	properties for strength limit state		
					moment		R _{int} (100mm bearing) (kN)
					M _p (kNm)	M _n (kNm)	
0.75	10.14	1211	15.29	0.488	3.96	5.75	35.0
0.90	12.04	1456	15.36	0.583	5.71	7.08	46.6
1.00	13.31	1620	15.41	0.647	6.72	7.98	56.1
Data for Stramit Condeck HP® Decking with HP Plus at every rib – add the value below to the above for the relevant decking thickness							
1.00	+3.6	#	#	#	+3.0	+2.6	

* Based on Z350 coating mass. # These properties assumed to be unchanged for design purposes. For I values refer to **Stramit Condeck HP Slab Designer™** software.

Cantilevered Balconies

Stramit Condeck HP® Decking can be used for cantilevered balconies in three ways. In each case the decking must be considered as formwork only (due to the negative moment there would be no benefit in utilising the composite capacity of the deck).

- Where the decking continues over and beyond the edge support** – In this case the decking may span, unpropped, up to 20% of the adjacent span length (back-span). Cantilevers greater than 20% can be evaluated using **Stramit Condeck HP Slab Designer™** software.
- Where the decking is at right angles to, and not continuous over, the edge support** – The decking must be fully propped as per Table 3a or 4a. In this case the full concrete depth can be assumed to be effective in slab design.
- Where the decking is in the same direction as the edge support** – Again the decking must be fully propped, as per Tables 3a to 4e as appropriate. However, in this case, only that portion of the slab above the decking ribs can be considered in slab design.

Overhangs

Stramit Condeck HP® Decking can be extended a small distance beyond a support beam without propping. As a general rule the deck may extend 300mm beyond the support for slab thicknesses and loadings used within this manual. In many cases this distance can be increased, but these need to be established by calculation using **Stramit Condeck HP Slab Designer™** software.

Slab Properties

kd is the neutral axis of the composite slab in the positive moment region for serviceability loads

$$kd = \left[-n\rho + \sqrt{n^2\rho^2 + 2n\rho} \right] d$$

n is modular ratio = $\frac{E_{\text{steel}}}{E_{\text{concrete}}}$

ρ is the reinforcement ratio = $\frac{A_{st}}{bd}$

where b is the slab width

d is effective slab depth = D - Y_{cg} (where D is total slab depth)

A_{st} - Area of tensile reinforcement

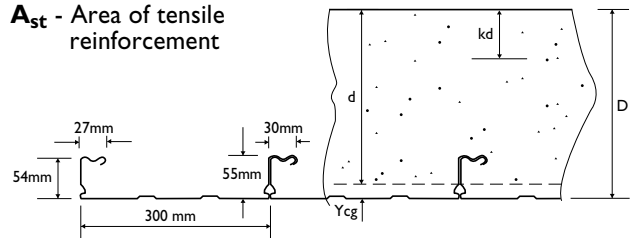

FORMWORK MODE DESIGN

Selection of **Stramit Condeck HP**® Decking thickness and propping requirements, including the option of HP Plus, can be made directly from Propping Tables 3 and 4 below and on the following pages.

The sections following show the derivation basis of this data. Composite slab design is also required to establish suitability for a given application.

Loading

Loadings are generally in accordance with AS1170.1 and AS3610.

Stage I loading – Construction and Stacked Materials.

Stage II loading – Wet Concrete (including an allowance for ponding), Pattern Loading, Live Loads. Construction load assumed to be 1kPa or 3kPa over 1.6m x 1.6m area.

*NOTE: Alternative stacked material loadings can be considered by using **Stramit Condeck HP Slab Designer**™ software.*

Although not included in the design data, consideration may need be given to wind uplift loads on unattached decking during Stage I construction. Refer to AS1170.2 for wind loads.

Deflection Limits

Actual deflection of metal decks vary significantly due to a range of practical field variables. These include concrete density, concrete placement position & levels of supports. Spans for rib deflections of span/240 and span/150 are given in Tables 3 and 4 respectively. These deflections should be regarded as nominal only.

Design Principles

In the formwork mode design checks are made for positive and negative moments, deflection and reaction, and critical interactions of these.

Critical design checks for formwork mode strength limit-state are:-

Single Spans

$$M_p^* \leq 0.82 M_p$$

Double/Continuous Spans

$$M_p^* \leq 0.82 M_p$$

$$\frac{M_n^*}{M_n} + 1.2 \frac{R_{int}^*}{R_{int}} \leq 1.2$$

Support Frame Types

Stramit Condeck HP® Decking is suitable for use on a wide range of support frame types. The most common applications are concrete beam or band beam, steel beam or composite steel beam, and masonry wall. Any structurally adequate continuous support members can be used provided they can withstand bearing loads from the decking.

TABLES 3 – DEFLECTION LIMIT SPAN/240

Table 3a

STRAMIT CONDECK HP® FORMWORK MODE – Maximum Single Span Lengths* (mm) – (deflection limited to span/240)															
slab thickness (mm)	0.75 mm BMT Stramit Condeck HP ® Decking					0.90 mm BMT Stramit Condeck HP ® Decking					1.00 mm BMT Stramit Condeck HP ® Decking				
	propping alternatives					propping alternatives					propping alternatives				
	none	HPplus	1 row	2 rows	3 rows	none	HPplus	1 row	2 rows	3 rows	none	HPplus	1 row	2 rows	3 rows
90	2100	2380	4880	7350	9830	2350	2510	5860	8050	11010	2450	2590	6190	8500	11630
100	2040	2310	4740	7140	9550	2280	2430	5690	7820	10690	2380	2520	6010	8260	11300
110	1990	2250	4610	6960	9300	2210	2370	5530	7610	10400	2310	2450	5850	8050	11000
120	1940	2190	4500	6780	9070	2160	2310	5390	7430	10140	2250	2390	5700	7850	10720
125	1920	2160	4440	6700	8960	2130	2280	5330	7340	10020	2220	2360	5640	7760	10600
130	1900	2140	4390	6630	8850	2110	2250	5270	7260	9910	2200	2330	5570	7670	10480
140	1860	2090	4290	6480	8660	2060	2200	5130	7100	9690	2150	2280	5450	7510	10250
150	1820	2050	4200	6340	8470	2020	2160	4930	6960	9490	2100	2230	5340	7360	10040
160	1780	2010	4110	6210	8300	1980	2120	4790	6820	9310	2060	2190	5230	7220	9850
170	1750	1970	3990	6090	8140	1940	2080	4660	6700	9140	2020	2150	5130	7090	9670
180	1720	1940	3880	5980	7990	1900	2040	4540	6580	8980	1990	2110	4950	6970	9510
190	1690	1900	3780	5870	7840	1870	2010	4430	6480	8830	1960	2080	4830	6850	9350
200	1660	1870	3680	5710	7630	1840	1970	4320	6370	8700	1920	2050	4710	6750	9200
210	1610	1840	3590	5570	7420	1810	1940	4220	6280	8570	1890	2010	4610	6650	9070
220	1600	1820	3420	5420	7230	1790	1920	4120	6190	8440	1870	1990	4500	6550	8940
230	1580	1790	3330	5290	7060	1760	1890	4030	6100	8330	1840	1960	4410	6460	8810
240	1560	1770	3240	5160	6880	1740	1860	3940	6020	8160	1820	1930	4310	6380	8700
250	1540	1750	3160	5050	6740	1720	1840	3860	5950	8010	1790	1910	4230	6300	8590

* based on concrete density 2400kg/m³, reo mass 50kg/m³, stacked material load 1.5kPa in pans, rib deflection limit span/240.

Slab thicknesses for shaded areas are not recommended for exposed ceilings. The threshold varies with **Stramit Condeck HP**® Decking thicknesses for 0.75, 100 slab or less is ok, for 0.90, 180 slab or less is ok, and for 1.00, 230 slab or less is ok.

Props must be equally spaced within the span. Internal supports and prop bearers should be a minimum of 100mm wide.

Table 3b

STRAMIT CONDECK HP® FORMWORK MODE – Maximum Double Span Lengths* (mm) – (deflection limited to span/240)															
slab thickness (mm)	0.75 mm BMT Stramit Condeck HP® Decking					0.90 mm BMT Stramit Condeck HP® Decking					1.00 mm BMT Stramit Condeck HP® Decking				
	none	HPplus	1 row	2 rows	3 rows	none	HPplus	1 row	2 rows	3 rows	none	HPplus	1 row	2 rows	3 rows
90	2440	3040	4910	7370	9820	2930	3170	5500	8210	10940	3090	3310	5810	8670	11560
100	2370	2950	4770	7160	9550	2840	3080	5340	7970	10630	3000	3210	5650	8430	11230
110	2300	2870	4650	6970	9300	2760	3000	5200	7760	10340	2920	3130	5500	8200	10930
120	2250	2800	4530	6800	9060	2690	2920	5070	7570	10090	2850	3050	5360	8000	10670
125	2220	2760	4480	6720	8960	2660	2890	5010	7480	9970	2820	3020	5300	7910	10540
130	2190	2730	4420	6640	8850	2630	2850	4950	7390	9860	2780	2980	5240	7820	10420
140	2140	2670	4330	6490	8650	2540	2790	4840	7230	9640	2720	2920	5120	7650	10200
150	2100	2620	4230	6350	8470	2460	2730	4740	7090	9450	2670	2860	5020	7500	9990
160	2050	2570	4150	6220	8300	2390	2680	4650	6950	9260	2610	2800	4920	7350	9800
170	1990	2520	4070	6100	8140	2330	2630	4570	6820	9090	2560	2750	4830	7220	9620
180	1940	2480	3990	5990	7990	2270	2590	4490	6700	8940	2470	2710	4750	7100	9460
190	1890	2430	3920	5880	7840	2210	2550	4410	6590	8790	2410	2660	4670	6980	9300
200	1840	2400	3810	5720	7630	2160	2510	4350	6490	8650	2350	2620	4600	6870	9160
210	1790	2320	3710	5560	7430	2110	2470	4280	6390	8520	2300	2580	4530	6770	9020
220	1710	2270	3610	5420	7240	2060	2430	4220	6300	8400	2250	2540	4470	6670	8890
230	1660	2220	3530	5300	7070	2010	2400	4160	6210	8280	2200	2510	4400	6580	8770
240	1620	2170	3440	5160	6890	1970	2370	4080	6130	8180	2150	2480	4350	6490	8660
250	1580	2130	3370	5050	6730	1930	2340	4000	6010	8020	2110	2440	4290	6410	8550

* based on concrete density 2400kg/m³, reo mass 50kg/m³, stacked material load 1.5kPa in pans, rib deflection limit span/240.

Table 3c

STRAMIT CONDECK HP® FORMWORK MODE – Maximum Continuous Span Lengths (mm) – (deflection limited to span/240)															
slab thickness (mm)	0.75 mm BMT Stramit Condeck HP® Decking					0.90 mm BMT Stramit Condeck HP® Decking					1.00 mm BMT Stramit Condeck HP® Decking				
	none	HPplus**	1 row	2 rows	3 rows	none	HPplus**	1 row	2 rows	3 rows	none	HPplus**	1 row	2 rows	3 rows
90	2450	2770	4910	7370	9820	2680	2890	5470	8210	10940	2830	3020	5780	8670	11560
100	2380	2690	4770	7160	9550	2600	2810	5310	7970	10630	2750	2930	5620	8420	11230
110	2320	2620	4650	6970	9300	2530	2740	5170	7760	10340	2680	2860	5470	8200	10930
120	2260	2560	4530	6800	9060	2470	2670	5040	7560	10090	2610	2790	5330	8000	10670
125	2230	2530	4480	6720	8960	2440	2640	4980	7480	9970	2580	2760	5270	7900	10540
130	2210	2500	4420	6640	8850	2420	2610	4930	7390	9860	2550	2730	5210	7810	10420
140	2160	2450	4320	6490	8650	2360	2560	4820	7230	9640	2500	2670	5100	7650	10200
150	2110	2400	4230	6350	8470	2320	2510	4720	7080	9450	2450	2620	5000	7490	9990
160	2070	2360	4150	6220	8300	2270	2460	4630	6950	9260	2400	2570	4900	7350	9800
170	2030	2310	4070	6100	8140	2230	2420	4550	6820	9090	2360	2530	4810	7220	9620
180	1990	2280	3990	5990	7990	2190	2380	4470	6700	8940	2320	2480	4730	7090	9460
190	1950	2240	3920	5880	7840	2160	2340	4390	6590	8790	2280	2440	4650	6980	9300
200	1900	2200	3810	5720	7630	2120	2300	4330	6490	8650	2250	2410	4580	6870	9160
210	1850	2170	3710	5560	7430	2090	2270	4260	6390	8520	2210	2370	4510	6760	9020
220	1800	2140	3610	5430	7240	2060	2240	4200	6300	8400	2180	2340	4450	6670	8890
230	1760	2110	3530	5300	7070	2030	2210	4140	6210	8280	2150	2310	4380	6580	8770
240	1720	2090	3440	5160	6890	2000	2180	4090	6130	8180	2120	2280	4330	6490	8660
250	1680	2060	3360	5050	6730	1980	2150	4010	6010	8020	2100	2250	4270	6410	8550

* based on concrete density 2400kg/m³, reo mass 50kg/m³, stacked material load 1.5kPa, rib deflection limit span/240.

** HP Plus accessory required at every rib but only in end spans.

Slab thicknesses for shaded areas are not recommended for exposed ceilings. The threshold varies with **Stramit Condeck HP®** Decking thicknesses for 0.75, 100 slab or less is ok, for 0.90, 180 slab or less is ok, and for 1.00, 230 slab or less is ok.

Props must be equally spaced within the span. Internal supports and prop bearers should be a minimum of 100mm wide.

Table 3d

STRAMIT CONDECK HP® FORMWORK MODE – Span Lengths with 1200mm wide propping frames												
slab thickness (mm)	Maximum Single Span Lengths* (mm) – (deflection limited to span/240)						Maximum Double or Continuous Span Lengths* (mm) – (deflection limited to span/240)					
	0.75mm BMT		0.90mm BMT		1.00mm BMT		0.75mm BMT		0.90mm BMT		1.00mm BMT	
	1 frame	2 frames	1 frame	2 frames	1 frame	2 frames	1 frame	2 frames	1 frame	2 frames	1 frame	2 frames
90	6060	9760	6350	10200	6650	10660	6130	9770	6430	10210	6740	10670
100	5910	9530	6190	9960	6490	10410	5980	9540	6270	9970	6570	10410
110	5780	9330	6050	9750	6340	10180	5850	9340	6130	9760	6420	10190
120	5660	9150	5930	9560	6210	9980	5730	9160	6000	9570	6280	9990
125	5600	9070	5870	9470	6150	9890	5670	9070	5940	9480	6220	9890
130	5550	8990	5810	9390	6090	9800	5620	9000	5890	9390	6160	9810
140	5450	8840	5710	9230	5980	9630	5520	8850	5780	9240	6050	9640
150	5360	8710	5620	9090	5880	9480	5430	8710	5680	9090	5950	9490
160	5280	8580	5530	8960	5780	9340	5350	8590	5600	8960	5850	9350
170	5210	8470	5450	8830	5700	9210	5270	8480	5510	8840	5770	9220
180	5140	8360	5370	8720	5620	9090	5200	8370	5440	8730	5690	9100
190	5070	8260	5300	8620	5550	8980	5130	8270	5370	8620	5610	8990
200	5010	8170	5240	8520	5480	8880	5070	8180	5300	8530	5540	8880
210	4950	8090	5180	8430	5410	8780	5010	8090	5240	8430	5480	8780
220	4900	8010	5120	8340	5350	8690	4960	8010	5180	8350	5420	8690
230	4850	7930	5070	8260	5290	8600	4910	7940	5130	8270	5360	8610
240	4800	7860	5020	8180	5240	8520	4830	7830	5080	8190	5300	8520
250	4760	7760	4970	8110	5190	8440	4740	7710	5030	8120	5250	8450

* based on concrete density 2400kg/m³, reo mass 50kg/m³, stacked material load 1.5kPa in pans, rib deflection limit span/240.

Table 3e

STRAMIT CONDECK HP® FORMWORK MODE – Span Lengths with 1500mm wide propping frames												
slab thickness (mm)	Maximum Single Span Lengths* (mm) – (deflection limited to span/240)						Maximum Double or Continuous Span Lengths* (mm) – (deflection limited to span/240)					
	0.75mm BMT		0.90mm BMT		1.00mm BMT		0.75mm BMT		0.90mm BMT		1.00mm BMT	
	1 frame	2 frames	1 frame	2 frames	1 frame	2 frames	1 frame	2 frames	1 frame	2 frames	1 frame	2 frames
90	6350	10350	6630	10770	6930	11220	6430	10360	6710	10780	7010	11230
100	6210	10130	6480	10540	6760	10970	6280	10140	6560	10550	6850	10980
110	6080	9940	6350	10340	6620	10760	6150	9950	6420	10350	6700	10770
120	5970	9770	6230	10160	6490	10560	6040	9770	6300	10170	6570	10570
125	5910	9690	6170	10070	6430	10470	5980	9700	6240	10080	6510	10480
130	5860	9610	6120	9990	6380	10390	5930	9620	6190	10000	6450	10400
140	5770	9470	6020	9840	6270	10230	5840	9480	6090	9850	6350	10240
150	5690	9340	5930	9710	6180	10080	5750	9350	6000	9710	6250	10090
160	5610	9230	5840	9580	6090	9950	5670	9230	5910	9590	6160	9960
170	5540	9120	5770	9470	6010	9830	5600	9130	5830	9470	6080	9830
180	5470	9020	5700	9360	5930	9710	5530	9030	5760	9370	6000	9720
190	5410	8930	5630	9260	5860	9610	5470	8930	5690	9270	5930	9610
200	5350	8840	5570	9170	5790	9510	5410	8850	5630	9170	5860	9510
210	5300	8760	5510	9080	5730	9410	5330	8760	5570	9090	5800	9420
220	5250	8650	5460	9000	5670	9330	5280	8650	5520	9000	5740	9330
230	5180	8520	5410	8920	5620	9240	5180	8530	5470	8930	5680	9250
240	5080	8370	5360	8850	5570	9170	5080	8370	5420	8860	5630	9170
250	4980	8230	5310	8780	5520	9090	4980	8230	5370	8790	5580	9100

* based on concrete density 2400kg/m³, reo mass 50kg/m³, stacked material load 1.5kPa in pans, rib deflection limit span/240.

Slab thicknesses for shaded areas are not recommended for exposed ceilings. The threshold varies with **Stramit Condeck HP®** Decking thicknesses for 0.75, 100 slab or less is ok, for 0.90, 180 slab or less is ok, and for 1.00, 230 slab or less is ok.

Frames must be equally spaced within the span. Internal supports and prop bearers should be a minimum of 100mm wide.

Loading

Loadings are generally in accordance with AS1170.1 and AS3610.

Stage I loading – Construction and Stacked Materials.

Stage II loading – Wet Concrete (including an allowance for ponding), Pattern Loading, Live Loads. Construction load assumed to be 1kPa or 3kPa over 1.6m x 1.6m area.

*NOTE: Alternative stacked material loadings can be considered by using **Stramit Condeck HP Slab Designer™** software.*

Although not included in the design data, consideration may need be given to wind uplift loads on unattached decking during Stage I construction. Refer to AS1170.2 for wind loads.

Deflection Limits

Actual deflection of metal decks vary significantly due to a range of practical field variables. These include concrete density, concrete placement position & levels of supports. Spans for rib deflections of span/240 and span/150 are given in Tables 3 and 4 respectively. These deflections should be regarded as nominal only.

TABLES 4 – DEFLECTION LIMIT SPAN/150

Table 4a

STRAMIT CONDECK HP® FORMWORK MODE – Maximum Single Span Lengths* (mm) – (deflection limited to span/150)															
slab thickness (mm)	0.75 mm BMT Stramit Condeck HP® Decking					0.90 mm BMT Stramit Condeck HP® Decking					1.00 mm BMT Stramit Condeck HP® Decking				
	propping alternatives					propping alternatives					propping alternatives				
	none	HPplus	1 row	2 rows	3 rows	none	HPplus	1 row	2 rows	3 rows	none	HPplus	1 row	2 rows	3 rows
90	2100	2720	4880	7350	9830	2540	2860	5920	8860	11870	2760	2960	6390	9610	12910
100	2040	2640	4740	7140	9550	2470	2780	5750	8620	11530	2680	2880	6260	9360	12550
110	1990	2580	4610	6960	9300	2400	2710	5590	8390	11220	2610	2800	6050	9120	12210
120	1940	2510	4500	6780	9070	2340	2650	5410	8180	10940	2550	2740	5860	8890	11900
125	1920	2480	4440	6700	8960	2310	2610	5320	8080	10810	2520	2710	5770	8790	11760
130	1900	2460	4390	6630	8850	2290	2590	5240	7990	10680	2490	2680	5680	8680	11620
140	1860	2400	4290	6480	8660	2240	2530	5080	7810	10440	2430	2620	5510	8490	11360
150	1820	2360	4200	6340	8470	2190	2480	4930	7640	10210	2380	2570	5360	8310	11110
160	1780	2310	4110	6210	8300	2140	2430	4790	7480	9940	2330	2520	5210	8140	10820
170	1750	2270	3990	6090	8140	2100	2390	4660	7280	9680	2280	2480	5080	7930	10540
180	1720	2230	3880	5980	7990	2060	2350	4540	7090	9430	2240	2430	4950	7730	10270
190	1690	2200	3780	5870	7840	2030	2310	4430	6910	9190	2200	2400	4830	7540	10020
200	1660	2160	3680	5710	7630	1990	2280	4320	6740	8970	2160	2360	4710	7360	9780
210	1610	2130	3590	5570	7420	1960	2240	4220	6580	8760	2130	2320	4610	7190	9560
220	1600	2100	3420	5420	7230	1930	2210	4120	6430	8560	2090	2290	4500	7030	9350
230	1580	2070	3330	5290	7060	1900	2180	4030	6290	8370	2060	2260	4410	6880	9150
240	1560	2040	3240	5160	6880	1870	2150	3940	6150	8180	2030	2230	4310	6730	8960
250	1540	2020	3160	5050	6740	1840	2130	3860	6010	8010	2000	2200	4230	6590	8770

* based on concrete density 2400kg/m³, reo mass 50kg/m³, stacked material load 1.5kPa, rib deflection limit span/150.

Slab thicknesses for shaded areas are not recommended for exposed ceilings. The threshold varies with **Stramit Condeck HP®** Decking thicknesses for 0.75, 100 slab or less is ok, for 0.90, 180 slab or less is ok, and for 1.00, 230 slab or less is ok.

Props must be equally spaced within the span. Internal supports and prop bearers should be a minimum of 100mm wide.

Table 4b

STRAMIT CONDECK HP® FORMWORK MODE – Maximum Double Span Lengths* (mm) – (deflection limited to span/150)															
slab thickness (mm)	0.75 mm BMT Stramit Condeck HP® Decking					0.90 mm BMT Stramit Condeck HP® Decking					1.00 mm BMT Stramit Condeck HP® Decking				
	propping alternatives					propping alternatives					propping alternatives				
	none	HPplus	1 row	2 rows	3 rows	none	HPplus	1 row	2 rows	3 rows	none	HPplus	1 row	2 rows	3 rows
90	2440	3170	4910	7370	9820	2960	3560	5930	8890	11770	3220	3750	6450	9670	12900
100	2370	3150	4770	7160	9550	2870	3440	5760	8640	11520	3130	3630	6270	9400	12540
110	2300	3050	4650	6970	9300	2790	3330	5610	8410	11220	3020	3520	6100	9150	12200
120	2250	2950	4530	6800	9060	2700	3230	5470	8200	10940	2930	3410	5950	8920	11900
125	2220	2910	4480	6720	8960	2660	3180	5400	8100	10800	2880	3370	5880	8810	11750
130	2190	2860	4420	6640	8850	2620	3140	5340	8010	10680	2840	3320	5810	8710	11610
140	2140	2780	4330	6490	8650	2540	3050	5220	7820	10430	2750	3230	5680	8510	11350
150	2100	2700	4230	6350	8470	2460	2970	5100	7660	10210	2680	3140	5550	8330	11100
160	2050	2630	4150	6220	8300	2390	2890	4970	7470	9960	2600	3070	5410	8120	10830
170	1990	2560	4070	6100	8140	2330	2820	4840	7270	9690	2540	2990	5270	7910	10550
180	1940	2490	3990	5990	7990	2270	2750	4710	7080	9440	2470	2920	5130	7710	10280
190	1890	2430	3920	5880	7840	2210	2690	4590	6900	9200	2410	2850	5010	7520	10030
200	1840	2380	3810	5720	7630	2160	2630	4480	6730	8980	2350	2790	4890	7350	9800
210	1790	2320	3710	5560	7430	2110	2570	4380	6570	8760	2300	2730	4780	7180	9570
220	1710	2270	3610	5420	7240	2060	2510	4280	6420	8560	2250	2670	4670	7020	9360
230	1660	2220	3530	5300	7070	2010	2460	4180	6280	8370	2200	2620	4570	6870	9160
240	1620	2170	3440	5160	6890	1970	2410	4090	6140	8190	2150	2570	4480	6720	8970
250	1580	2130	3370	5050	6730	1930	2360	4000	6010	8020	2110	2520	4380	6590	8780

* based on concrete density 2400kg/m³, reo mass 50kg/m³, stacked material load 1.5kPa, rib deflection limit span/150.

Table 4c

STRAMIT CONDECK HP® FORMWORK MODE – Maximum Continuous Span Lengths* (mm) – (deflection limited to span/150)															
slab thickness (mm)	0.75 mm BMT Stramit Condeck HP® Decking					0.90 mm BMT Stramit Condeck HP® Decking					1.00 mm BMT Stramit Condeck HP® Decking				
	propping alternatives					propping alternatives					propping alternatives				
	none	HPplus	1 row	2 rows	3 rows	none	HPplus	1 row	2 rows	3 rows	none	HPplus	1 row	2 rows	3 rows
90	2450	3030	4910	7370	9820	2950	3260	5570	8890	11770	3200	3400	6450	9670	12900
100	2380	2940	4770	7160	9550	2870	3180	5660	8640	11520	3120	3320	6270	9400	12540
110	2320	2850	4650	6970	9300	2790	3100	5610	8410	11220	3040	3240	6100	9150	12200
120	2260	2770	4530	6800	9060	2720	3040	5470	8200	10940	2960	3170	5950	8920	11900
125	2230	2740	4480	6720	8960	2690	3000	5400	8100	10800	2930	3140	5870	8810	11750
130	2210	2680	4420	6640	8850	2660	2970	5340	8010	10680	2890	3100	5800	8710	11610
140	2160	2610	4320	6490	8650	2600	2920	5210	7820	10430	2830	3040	5670	8510	11350
150	2110	2550	4230	6350	8470	2540	2860	5100	7660	10210	2770	2990	5550	8330	11100
160	2070	2440	4150	6220	8300	2490	2810	4980	7470	9960	2710	2940	5410	8120	10830
170	2030	2440	4070	6100	8140	2420	2770	4840	7270	9690	2640	2890	5270	7910	10550
180	1990	2390	3990	5990	7990	2360	2720	4720	7080	9440	2570	2840	5140	7710	10280
190	1950	2340	3920	5880	7840	2300	2680	4600	6900	9200	2510	2800	5010	7520	10030
200	1900	2290	3810	5720	7630	2240	2640	4490	6730	8980	2450	2760	4900	7350	9800
210	1850	2260	3710	5560	7430	2190	2600	4380	6570	8760	2390	2720	4780	7180	9570
220	1800	2230	3610	5430	7240	2140	2570	4280	6420	8560	2340	2690	4680	7020	9360
230	1760	2190	3530	5300	7070	2090	2540	4180	6280	8370	2290	2650	4580	6870	9160
240	1720	2140	3440	5160	6890	2050	2500	4090	6140	8190	2240	2620	4480	6720	8970
250	1680	2120	3360	5050	6730	2000	2450	4010	6010	8020	2190	2590	4390	6590	8780

* based on concrete density 2400kg/m³, reo mass 50kg/m³, stacked material load 1.5kPa, rib deflection limit span/150.

Slab thicknesses for shaded areas are not recommended for exposed ceilings. The threshold varies with **Stramit Condeck HP®** Decking thicknesses for 0.75, 100 slab or less is ok, for 0.90, 180 slab or less is ok, and for 1.00, 230 slab or less is ok.

Props must be equally spaced within the span. Internal supports and prop bearers should be a minimum of 100mm wide.

Table 4d

STRAMIT CONDECK HP® FORMWORK MODE – Span Lengths with 1200mm wide propping frames												
slab thickness (mm)	Maximum Single Span Lengths* (mm) – (deflection limited to span/150)						Maximum Double or Continuous Span Lengths* (mm) – (deflection limited to span/150)					
	0.75mm BMT		0.90mm BMT		1.00mm BMT		0.75mm BMT		0.90mm BMT		1.00mm BMT	
	1 frame	2 frames	1 frame	2 frames	1 frame	2 frames	1 frame	2 frames	1 frame	2 frames	1 frame	2 frames
90	6260	10040	7130	11390	7480	11910	6290	10050	7220	11390	7570	11920
100	6120	9820	6960	11130	7300	11640	6150	9830	7050	11130	7390	11650
110	5980	9620	6810	10890	7140	11390	6010	9630	6890	10900	7230	11400
120	5860	9440	6670	10680	6990	11170	5890	9440	6750	10690	7080	11180
125	5810	9350	6600	10580	6930	11070	5830	9360	6690	10590	7010	11080
130	5750	9270	6540	10490	6860	10970	5780	9270	6620	10500	6940	10980
140	5650	9120	6430	10310	6740	10780	5670	9120	6510	10320	6820	10790
150	5550	8970	6320	10150	6620	10610	5580	8970	6400	10160	6710	10620
160	5460	8840	6220	10000	6520	10460	5490	8840	6300	10010	6600	10460
170	5380	8710	6130	9860	6420	10310	5400	8710	6210	9870	6500	10320
180	5300	8580	6040	9740	6330	10170	5320	8580	6120	9740	6410	10180
190	5230	8470	5970	9620	6250	10040	5240	8470	6040	9620	6330	10050
200	5160	8360	5890	9500	6170	9920	5170	8360	5960	9510	6250	9930
210	5090	8250	5820	9350	6100	9810	5100	8250	5850	9360	6170	9820
220	5030	8160	5750	9220	6030	9710	5040	8160	5750	9220	6100	9710
230	4950	8030	5660	9080	5960	9610	4930	8000	5650	9080	6030	9610
240	4860	7900	5570	8950	5900	9510	4830	7850	5560	8950	5970	9520
250	4780	7770	5480	8810	5840	9420	4740	7710	5470	8810	5880	9430

* based on concrete density 2400kg/m³, reo mass 50kg/m³, stacked material load 1.5kPa in pans, rib deflection limit span/150.

Table 4e

STRAMIT CONDECK HP® FORMWORK MODE – Span Lengths with 1500mm wide propping frames												
slab thickness (mm)	Maximum Single Span Lengths* (mm) – (deflection limited to span/150)						Maximum Double or Continuous Span Lengths* (mm) – (deflection limited to span/150)					
	0.75mm BMT		0.90mm BMT		1.00mm BMT		0.75mm BMT		0.90mm BMT		1.00mm BMT	
	1 frame	2 frames	1 frame	2 frames	1 frame	2 frames	1 frame	2 frames	1 frame	2 frames	1 frame	2 frames
90	6520	10580	7390	11920	7730	12430	6550	10580	7480	11930	7820	12440
100	6380	10350	7220	11670	7550	12160	6400	10350	7310	11680	7650	12170
110	6250	10150	7070	11440	7390	11930	6270	10150	7160	11450	7490	11940
120	6130	9960	6940	11240	7250	11710	6140	9960	7020	11250	7340	11720
125	6080	9880	6880	11140	7190	11610	6080	9880	6960	11150	7280	11620
130	6020	9790	6820	11050	7120	11520	6030	9790	6900	11060	7210	11530
140	5910	9630	6700	10880	7010	11340	5920	9630	6790	10890	7090	11350
150	5820	9480	6600	10730	6900	11170	5820	9490	6680	10740	6980	11180
160	5720	9350	6510	10580	6800	11020	5730	9350	6590	10590	6880	11030
170	5640	9220	6420	10450	6700	10880	5640	9220	6500	10460	6780	10890
180	5560	9100	6340	10330	6620	10750	5560	9100	6410	10340	6700	10760
190	5480	8980	6260	10210	6530	10620	5490	8980	6340	10220	6610	10630
200	5410	8870	6190	10100	6460	10510	5410	8870	6260	10110	6540	10520
210	5340	8770	6120	10000	6390	10400	5350	8770	6170	10010	6460	10410
220	5280	8670	6060	9840	6320	10300	5280	8670	6060	9840	6390	10310
230	5180	8520	5960	9690	6260	10200	5180	8530	5950	9690	6330	10210
240	5080	8370	5860	9530	6200	10110	5080	8370	5850	9530	6270	10120
250	4980	8230	5750	9380	6140	10030	4980	8230	5750	9380	6180	10030

* based on concrete density 2400kg/m³, reo mass 50kg/m³, stacked material load 1.5kPa in pans, rib deflection limit span/150.

Slab thicknesses for shaded areas are not recommended for exposed ceilings. The threshold varies with **Stramit Condeck HP®** Decking thicknesses for 0.75, 100 slab or less is ok, for 0.90, 180 slab or less is ok, and for 1.00, 230 slab or less is ok.

Frames must be equally spaced within the span and should be a minimum of 100mm wide.

COMPOSITE SLAB DESIGN

The selection of **Stramit Condeck HP**® Composite Slabs can be made directly from the Span Tables following. Subsequent sections show the derivation basis of this data, that is based on AS3600:2009.

Composite Table Assumptions

The tables given on pages 14 to 37 include propping limitations as well as the composite slab capacities. They can be used directly if the following apply:

Concrete compressive strength $f'_c = 25\text{MPa}$, 32MPa or 40MPa .

Base metal thickness of Condeck HP = 0.75, 0.90 or 1.00mm.

Estimated maximum deflection of rib under wet concrete = $\text{Span}/240$.

(The prop requirements shown in the composite tables therefore relate to the deflection limit of $L/240$ with individual props. To adopt $L/150$ deflection limits or use propping frames ignore the prop requirements in the composite tables and adopt the propping requirement in tables 3a-e or 4a-e.)

Short term live load factor for calculating slab deflection $\Psi_s = 0.7$.

Long term live load factor for calculating slab deflection $\Psi_l = 0.4$.

Density of concrete + allowance for weight of reinforcement = $2500\text{kg}/\text{m}^3$.

Dead Load = weight of slab and steel + 1kPa superimposed dead load.

L/D ratio limited to minimum of 15.

Based on D500N reinforcement for negative reinforcement and fire emergency reinforcement.

Total slab deflection $\leq \text{Span}/250$.

Incremental slab deflection $\leq \text{Span}/500$ (for slabs supporting masonry partitions where provision is made to minimize the effect of movement).

Span limits for the formwork mode have been determined according to the design rules stated on page 6 for single span and continuous span decking.

It is assumed that for a single span slab, the **Stramit Condeck HP**® sheeting would also be a single span either with or without props. For a continuous span slab, the **Stramit Condeck HP**® sheeting would be continuous over at least one permanent support.

In the case of continuous slabs, the ratio of an internal span to an end span shall be no more than 1.2 and no less than 1.0.

All loads have been assumed to be uniformly distributed and other types of loading have not been taken into account.

The slab has a uniform cross section.

Bending moments at supports are caused only by the actions of loads applied to the slab.

Redistribution of negative moments allowed for.

When computing the deflection of the slab, it is assumed that the effective load acts on all spans.

The design shrinkage strain used in finding the deflection is computed based on the following assumptions.

- The soffit of the slab is ignored when determining the exposed surface, due to the presence of the **Stramit Condeck HP**® sheeting.
- The final drying basic shrinkage strain ($\epsilon_{csd,b}^s$) is taken as 1000×10^{-6} . For Sydney, Melbourne and Brisbane locations, reduced values are possible and a more economical design can be achieved by using the **Stramit Condeck HP Slab Designer**™ software.
- The time is assumed to be 30 years when calculating the shrinkage strain.

Reduction in M_{cr} values due to shrinkage cracking allowed for assuming slabs to be in internal exposure conditions.

No allowance has been made for

- Two-way action
- Expected load history
- Additional cracking, tension stiffening, creep & shrinkage of concrete, except that allowed for by the multiplier k_{cs} .

Partial shear connection theory used to determine positive moment capacity and to check for slip under serviceability conditions.

Shrinkage and temperature mesh assumed to be placed on top of decking for slabs 125mm and under and at top of slab for thicker slabs. k_{cs} is therefore taken as 2.0 for slab depths of 125 and under.

If the assumptions given in this section are not valid then calculations would need to be performed using the **Stramit Condeck HP Slab Designer**™ software.

Composite Span Tables

In the following limit-state composite slab tables the designation

a denotes 0.75mm **Stramit Condeck HP**® Decking,

b is 0.90mm and

c is 1.00mm.

PAGE

Tables 5a, 5b, 5c – Single spans, Total deflection, 25 MPa concrete	14-15
Tables 6a, 6b, 6c – Single spans, Total deflection, 32 MPa concrete	16-17
Tables 7a, 7b, 7c – Single spans, Total deflection, 40 MPa concrete	18-19
Tables 8a, 8b, 8c – Single spans, Incremental deflection, 25 MPa concrete	20-21
Tables 9a, 9b, 9c – Single spans, Incremental deflection, 32 MPa concrete	22-23
Tables 10a, 10b, 10c – Single spans, Incremental deflection, 40 MPa concrete	24-25
Tables 11a, 11b, 11c – Continuous spans, Total deflection, 25 MPa concrete	26-27
Tables 12a, 12b, 12c – Continuous spans, Total deflection, 32 MPa concrete	28-29
Tables 13a, 13b, 13c – Continuous spans, Total deflection, 40 MPa concrete	30-31
Tables 14a, 14b, 14c – Continuous spans, Incremental deflection, 25 MPa concrete	32-33
Tables 15a, 15b, 15c – Continuous spans, Incremental deflection, 32 MPa concrete	34-35
Tables 16a, 16b, 16c – Continuous spans, Incremental deflection, 40 MPa concrete	36-37

(Double spans may be considered as continuous spans in composite design)

Live load values less than 1.5kPa have been included in the tables to enable interpolation.

single spans

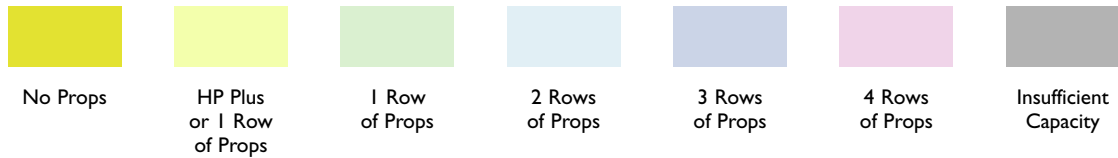

Additional notes to tables:-

The span/depth (L/D) ratio of any slab is assumed to be not less than 15.

Areas indicated as HP Plus allow the option of using 1 row of props or, utilising **Stramit Condeck HP Plus™** End Span Accessory installed as per the conditions within this manual.

All spans shown are effective spans as defined on page 4.

Refer also to the comprehensive table notes on page 12.

Table 5a

0.75mm STRAMIT CONDECK HP® COMPOSITE SLAB – using 25MPa concrete																					
SINGLE SPAN – limited by strength or total deflection																					
– MAXIMUM IMPOSED LIVE LOAD (kPa)																					
slab thickness (mm)	span length (mm)																				
	1800	2000	2200	2400	2600	2800	3000	3200	3400	3600	3800	4000	4200	4400	4600	4800	5000	5200	5400		
90	17.5	10.5	6.5	3.5	1.0																
100	20.0	18.0	12.0	7.5	4.5	2.0	0.5														
110	20.0	20.0	17.0	11.5	7.5	4.5	2.0	0.5													
120		20.0	20.0	16.0	11.0	7.0	4.5	2.5	0.5												
125		20.0	20.0	18.5	13.0	9.0	5.5	3.5	1.5												
130				20.0	15.0	10.5	7.0	4.5	2.5	1.0											
140					20.0	14.5	10.5	7.0	4.5	3.0	1.0										
150					20.0	19.0	14.0	10.0	7.0	4.5	3.0	1.5									
160						20.0	18.0	13.5	10.0	7.0	5.0	3.0	2.0	0.5							
	HP Plus					1 row of props						2 rows of props				insufficient capacity					
(mm)	3200	3400	3600	3800	4000	4200	4400	4600	4800	5000	5200	5400	5600	5800	6000	6200	6400	6600	6800		
170	17.0	13.0	9.5	7.0	5.0	3.5	2.0	0.5													
180	19.5	16.5	12.5	9.5	7.0	5.0	3.5	2.0													
190	20.0	18.5	16.0	12.5	9.5	7.0	5.0	3.5	2.0	1.0											
200	20.0	19.5	17.5	15.5	12.0	9.5	7.0	5.0	3.5	2.0	1.0										
210	20.0	20.0	18.5	17.0	14.5	11.5	9.0	7.0	5.0	3.5	2.0	1.0									
220		20.0	19.5	18.0	16.5	14.0	11.0	8.5	6.5	5.0	3.5	2.0	1.0								
230			20.0	18.5	17.0	15.5	13.5	11.0	8.5	6.5	5.0	3.5	2.0	1.0							
240			20.0	19.5	18.0	16.5	15.0	13.0	10.5	8.5	6.5	5.0	3.5	2.0	1.0						
250				20.0	18.5	17.0	15.5	14.5	12.5	10.0	8.0	6.0	4.5	3.0	2.0	1.0					
					2 rows of props						3 rows of props						insufficient capacity				

Slab thicknesses shaded are not recommended for exposed ceilings. The threshold varies with **Stramit Condeck HP®** Decking thicknesses for 0.75, 100 slab or less is ok, for 0.90, 180 slab or less is ok, and for 1.00, 230 slab or less is ok.

single spans

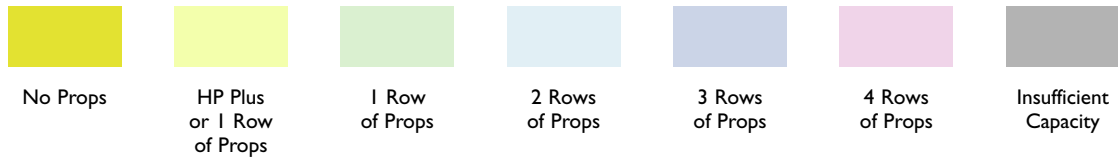

Additional notes to tables:-

The span/depth (L/D) ratio of any slab is assumed to be not less than 15.

Areas indicated as HP Plus allow the option of using 1 row of props or, utilising **Stramit Condeck HP Plus™** End Span Accessory installed as per the conditions within this manual.

All spans shown are effective spans as defined on page 4.

Refer also to the comprehensive table notes on page 12.

Table 6a

0.75mm STRAMIT CONDECK HP® COMPOSITE SLAB – using 32MPa concrete																			
SINGLE SPAN – limited by strength or total deflection																			
– MAXIMUM IMPOSED LIVE LOAD (kPa)																			
slab thickness (mm)	span length (mm)																		
	1800	2000	2200	2400	2600	2800	3000	3200	3400	3600	3800	4000	4200	4400	4600	4800	5000	5200	5400
90	18.5	11.5	7.0	4.0	1.5														
100	20.0	19.5	13.0	8.5	5.0	3.0	1.0												
110	20.0	20.0	18.5	12.5	8.5	5.5	3.0	1.5											
120	20.0	20.0	20.0	17.5	12.5	8.5	6.0	3.5	2.0	0.5									
125		20.0	20.0	20.0	14.5	10.5	7.0	4.5	3.0	1.5									insufficient capacity
130		20.0	20.0	20.0	17.0	12.5	8.5	6.0	4.0	2.0	1.0								
140			20.0	20.0	20.0	16.5	12.5	9.0	6.5	4.5	2.5	1.5							
150				20.0	20.0	20.0	16.0	12.0	9.0	6.5	4.5	3.0	1.5						
160				20.0	20.0	20.0	20.0	16.0	12.0	9.0	7.0	5.0	3.5	2.0	1.0				
	HPPlus			1 row of props									2 rows of props						
(mm)	3200	3400	3600	3800	4000	4200	4400	4600	4800	5000	5200	5400	5600	5800	6000	6200	6400	6600	6800
170	18.5	15.5	12.0	9.0	7.0	5.0	3.5	2.0	1.0										
180	20.0	18.0	15.0	11.5	9.0	7.0	5.0	3.5	2.0	1.0									
190	20.0	19.0	17.0	15.0	12.0	9.5	7.0	5.5	4.0	2.5	1.5								
200	20.0	20.0	18.0	16.5	14.5	11.5	9.0	7.0	5.5	4.0	2.5	1.5							
210	20.0	20.0	19.0	17.0	15.5	14.0	11.5	9.0	7.0	5.5	4.0	2.5	1.5						insufficient capacity
220		20.0	20.0	18.0	16.5	15.0	13.5	11.0	9.0	7.0	5.0	4.0	2.5	1.5					
230			20.0	19.0	17.0	15.5	14.5	13.0	11.0	9.0	7.0	5.5	4.0	3.0	1.5				
240				20.0	19.5	18.0	16.5	15.0	14.0	13.0	11.0	9.0	7.0	5.5	4.0	2.5	1.5		
250					20.0	19.0	17.0	16.0	14.5	13.5	12.5	10.5	8.5	7.0	5.0	4.0	2.5	1.5	
	2 rows of props										3 rows of props								

Slab thicknesses shaded are not recommended for exposed ceilings. The threshold varies with **Stramit Condeck HP®** Decking thicknesses for 0.75, 100 slab or less is ok, for 0.90, 180 slab or less is ok, and for 1.00, 230 slab or less is ok.

single spans

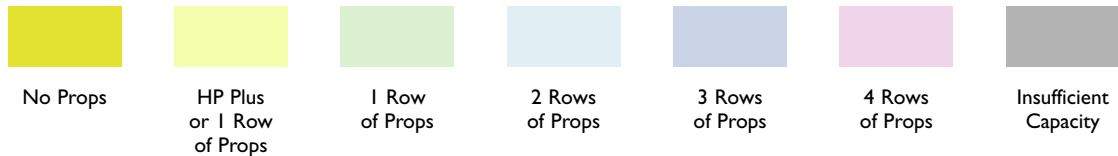
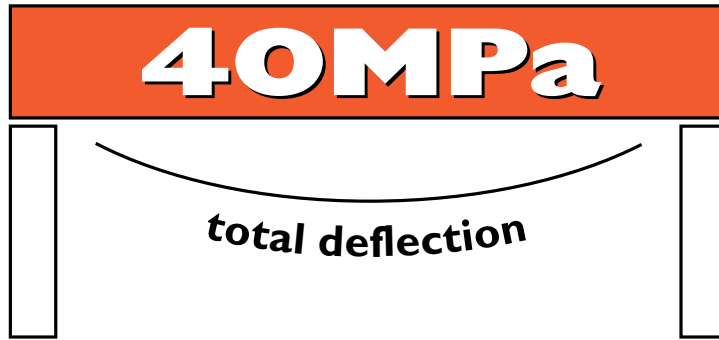

Additional notes to tables:-

The span/depth (L/D) ratio of any slab is assumed to be not less than 15.

Areas indicated as HP Plus allow the option of using 1 row of props or, utilising **Stramit Condeck HP Plus™** End Span Accessory installed as per the conditions within this manual.

All spans shown are effective spans as defined on page 4.

Refer also to the comprehensive table notes on page 12.

Table 7a

0.75mm STRAMIT CONDECK HP® COMPOSITE SLAB – using 40MPa concrete																													
SINGLE SPAN – limited by strength or total deflection																													
– MAXIMUM IMPOSED LIVE LOAD (kPa)																													
slab thickness (mm)	span length (mm)																												
	1800	2000	2200	2400	2600	2800	3000	3200	3400	3600	3800	4000	4200	4400	4600	4800	5000	5200	5400										
90	19.0	12.0	7.5	4.5	2.0	0.5	insufficient capacity																						
100	20.0	20.0	14.5	9.5	6.5	4.0														2.0	0.5								
110	20.0	20.0	20.0	14.5	10.0	7.0														4.5	2.5	1.5							
120	20.0	20.0	20.0	19.5	14.5	10.5														7.5	5.0	3.0	1.5						
125	20.0	20.0	20.0	20.0	16.5	12.0														9.0	6.5	4.5	2.5	1.5					
130	20.0	20.0	20.0	20.0	19.0	14.5														10.5	7.5	5.5	3.5	2.0	1.0				
140	20.0	20.0	20.0	20.0	20.0	19.0														14.5	11.0	8.0	6.0	4.0	2.5	1.5			
150	20.0	20.0	20.0	20.0	20.0	20.0														18.5	14.5	11.0	8.5	6.0	4.5	3.0	2.0	0.5	
160	20.0	20.0	20.0	20.0	20.0	20.0														20.0	18.0	14.5	11.5	8.5	6.5	5.0	3.5	2.0	1.0
	HP Plus		1 row of props																	2 rows of props									
(mm)	3200	3400	3600	3800	4000	4200	4400	4600	4800	5000	5200	5400	5600	5800	6000	6200	6400	6600	6800										
170	19.0	17.0	14.5	11.0	9.0	7.0	5.0	3.5	2.5	1.0	insufficient capacity																		
180	20.0	18.0	16.0	14.0	11.5	9.0	7.0	5.0	3.5	2.5										1.5									
190	20.0	19.0	17.0	15.5	14.0	11.5	9.0	7.0	5.5	4.0										2.5	1.5								
200	20.0	20.0	18.0	16.5	15.0	13.5	11.5	9.0	7.0	5.5										4.0	3.0	1.5							
210	20.0	20.0	19.0	17.0	15.5	14.5	13.0	11.0	9.0	7.0										5.5	4.0	3.0	2.0	1.0					
220	20.0	20.0	20.0	18.0	16.5	15.0	14.0	12.5	11.0	9.0										7.0	5.5	4.0	3.0	2.0	1.0				
230	20.0	20.0	20.0	19.0	17.5	16.0	14.5	13.5	12.5	11.0										9.0	7.5	6.0	4.5	3.0	2.0	1.0			
240	20.0	20.0	20.0	20.0	18.0	16.5	15.0	14.0	13.0	12.0										11.0	9.0	7.5	5.5	4.5	3.0	2.0	1.0		
250	20.0	20.0	20.0	20.0	19.0	17.5	16.0	14.5	13.5	12.5										11.5	10.5	9.0	7.0	5.5	4.5	3.0	2.0		
	2 rows of props						3 rows of props																	1.0 4 rows of props					

Slab thicknesses shaded are not recommended for exposed ceilings. The threshold varies with **Stramit Condeck HP®** Decking thicknesses for 0.75, 100 slab or less is ok, for 0.90, 180 slab or less is ok, and for 1.00, 230 slab or less is ok.

Table 7b

0.90mm STRAMIT CONDECK HP® COMPOSITE SLAB – using 40MPa concrete SINGLE SPAN – limited by strength or total deflection – MAXIMUM IMPOSED LIVE LOAD (kPa)																										
slab thickness (mm)	span length (mm)																									
	1800	2000	2200	2400	2600	2800	3000	3200	3400	3600	3800	4000	4200	4400	4600	4800	5000	5200	5400							
90	20.0	14.5	9.0	5.5	3.0	1.0	insufficient capacity																			
100	20.0	20.0	16.0	11.0	7.0	4.5	2.5	1.0	insufficient capacity																	
110	20.0	20.0	20.0	16.0	11.0	7.5	5.0	3.0	1.5	insufficient capacity																
120	20.0	20.0	20.0	20.0	15.5	11.0	8.0	5.5	3.5	2.0	0.5	insufficient capacity														
125		20.0	20.0	20.0	18.5	13.5	9.5	6.5	4.5	2.5	1.5	insufficient capacity														
130		20.0	20.0	20.0	20.0	15.5	11.5	8.0	5.5	3.5	2.0	1.0	insufficient capacity													
140			20.0	20.0	20.0	20.0	15.5	11.5	8.5	6.0	4.0	2.5	1.5	insufficient capacity												
150				20.0	20.0	20.0	20.0	15.0	11.5	8.5	6.5	4.5	3.0	1.5	insufficient capacity											
160	0 props	HP Plus		20.0	20.0	20.0	20.0	19.0	15.0	11.5	9.0	6.5	5.0	3.0	2.0	1.0	insufficient capacity									
								1 row of props																		2 rows of props

(mm)	3200	3400	3600	3800	4000	4200	4400	4600	4800	5000	5200	5400	5600	5800	6000	6200	6400	6600	6800				
170	20.0	18.0	15.0	11.5	9.0	7.0	5.0	3.5	2.0	1.0	insufficient capacity												
180	20.0	19.0	17.0	14.5	11.5	9.0	7.0	5.0	3.5	2.5	1.5	insufficient capacity											
190	20.0	20.0	18.0	16.5	14.5	11.5	9.0	7.5	5.5	4.0	2.5	1.5	insufficient capacity										
200	20.0	20.0	19.0	17.0	15.5	14.5	11.5	9.5	7.5	5.5	4.0	2.5	1.5	insufficient capacity									
210	20.0	20.0	20.0	18.0	16.5	15.0	14.0	11.5	9.0	7.0	5.5	4.0	3.0	1.5	insufficient capacity								
220		20.0	20.0	19.0	17.0	16.0	14.5	13.5	11.0	9.0	7.0	5.5	4.0	3.0	1.5	insufficient capacity							
230			20.0	19.5	18.0	16.5	15.0	14.0	13.0	11.5	9.0	7.5	5.5	4.0	3.0	2.0	1.0	insufficient capacity					
240			20.0	20.0	19.0	17.5	16.0	14.5	13.5	12.5	11.0	9.0	7.0	5.5	4.5	3.0	2.0	1.0	insufficient capacity				
250				20.0	19.5	18.0	16.5	15.0	14.0	13.0	12.0	11.0	9.0	7.0	5.5	4.0	3.0	2.0	1.0				
								1 row of props								2 rows of props				3 rows of props			

Table 7c

1.00mm STRAMIT CONDECK HP® COMPOSITE SLAB – using 40MPa concrete SINGLE SPAN – limited by strength or total deflection – MAXIMUM IMPOSED LIVE LOAD (kPa)																										
slab thickness (mm)	span length (mm)																									
	1800	2000	2200	2400	2600	2800	3000	3200	3400	3600	3800	4000	4200	4400	4600	4800	5000	5200	5400							
90	20.0	16.5	10.5	6.5	3.5	1.5	insufficient capacity																			
100	20.0	20.0	17.5	12.0	8.0	5.0	2.5	1.0	insufficient capacity																	
110	20.0	20.0	20.0	17.5	12.0	8.0	5.5	3.0	1.5	insufficient capacity																
120	20.0	20.0	20.0	20.0	17.0	12.0	8.5	5.5	3.5	2.0	0.5	insufficient capacity														
125		20.0	20.0	20.0	19.5	14.0	10.0	7.0	5.0	3.0	1.5	insufficient capacity														
130		20.0	20.0	20.0	20.0	16.5	12.0	8.5	6.0	4.0	2.5	1.0	insufficient capacity													
140			20.0	20.0	20.0	20.0	16.5	12.0	9.0	6.5	4.5	2.5	1.5	insufficient capacity												
150				20.0	20.0	20.0	20.0	16.0	12.0	9.0	6.5	4.5	3.0	1.5	insufficient capacity											
160	0 props			20.0	20.0	20.0	20.0	19.5	16.0	12.0	9.5	7.0	5.0	3.5	2.0	1.0	insufficient capacity									
								1 row of props																		

(mm)	3200	3400	3600	3800	4000	4200	4400	4600	4800	5000	5200	5400	5600	5800	6000	6200	6400	6600	6800				
170	20.0	18.5	15.5	12.0	9.5	7.0	5.0	3.5	2.0	1.0	insufficient capacity												
180	20.0	19.5	17.5	15.0	12.0	9.0	7.0	5.0	3.5	2.5	1.5	insufficient capacity											
190	20.0	20.0	18.5	17.0	15.0	12.0	9.5	7.0	5.5	4.0	2.5	1.5	insufficient capacity										
200	20.0	20.0	19.5	17.5	16.0	14.5	12.0	9.5	7.5	5.5	4.0	2.5	1.5	insufficient capacity									
210	20.0	20.0	20.0	18.5	17.0	15.5	14.0	11.5	9.5	7.5	5.5	4.0	3.0	1.5	insufficient capacity								
220		20.0	20.0	19.5	17.5	16.0	15.0	13.5	11.5	9.0	7.5	5.5	4.0	3.0	1.5	insufficient capacity							
230			20.0	20.0	18.5	17.0	15.5	14.5	13.0	11.5	9.5	7.5	5.5	4.0	3.0	2.0	1.0	insufficient capacity					
240			20.0	20.0	19.5	17.5	16.5	15.0	14.0	13.0	11.0	9.0	7.0	5.5	4.0	3.0	2.0	1.0	insufficient capacity				
250				20.0	20.0	18.5	17.0	15.5	14.5	13.5	12.5	11.0	9.0	7.0	5.5	4.0	3.0	2.0	1.0				
								1 row of props								2 rows of props				3 rows of props			

Slab thicknesses shaded are not recommended for exposed ceilings. The threshold varies with **Stramit Condeck HP®** Decking thicknesses for 0.75, 100 slab or less is ok, for 0.90, 180 slab or less is ok, and for 1.00, 230 slab or less is ok.

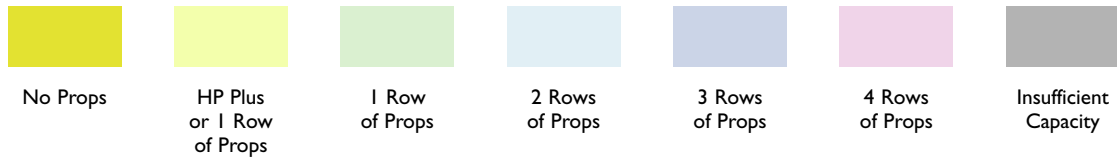
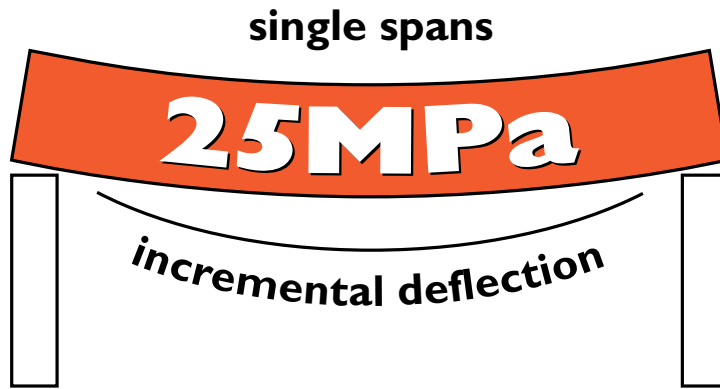

Additional notes to tables:-

The span/depth (L/D) ratio of any slab is assumed to be not less than 15.

Areas indicated as HP Plus allow the option of using 1 row of props or, utilising **Stramit Condeck HP Plus™** End Span Accessory installed as per the conditions within this manual.

All spans shown are effective spans as defined on page 4.

Refer also to the comprehensive table notes on page 12.

Table 8a

0.75mm STRAMIT CONDECK HP® COMPOSITE SLAB – using 25MPa concrete																																			
SINGLE SPAN – limited by strength or incremental deflection																																			
– MAXIMUM IMPOSED LIVE LOAD (kPa)																																			
slab thickness (mm)	span length (mm)																																		
	1800	2000	2200	2400	2600	2800	3000	3200	3400	3600	3800	4000	4200	4400	4600	4800	5000	5200	5400																
90	7.5	4.0	2.0	0.5	insufficient capacity																														
100	12.5	8.0	5.0	2.5													1.0																		
110	18.0	11.5	7.5	4.5													2.5	1.0																	
120	20.0	16.0	11.0	7.5													4.5	3.0	1.5																
125		18.5	13.0	9.0													6.0	4.0	2.0	1.0															
130		20.0	15.0	10.5													7.0	5.0	3.0	1.5															
140			20.0	14.5													10.5	7.5	5.0	3.5	2.0	0.5													
150				18.5													13.5	10.0	7.5	5.0	3.5	2.0	1.0												
160				20.0													18.0	13.5	10.0	7.5	5.5	3.5	2.5	1.0											
	<i>HP Plus</i>		<i>1 row of props</i>																																
(mm)	3200	3400	3600	3800													4000	4200	4400	4600	4800	5000	5200	5400	5600	5800	6000	6200	6400	6600	6800				
170	10.0	7.5	5.5	3.5													2.5	1.5	insufficient capacity																
180	12.5	9.5	7.0	5.5													4.0	2.5													1.5				
190	15.5	12.5	9.5	7.5													5.5	4.0													2.5	1.5			
200	19.0	15.0	12.0	9.5													7.0	5.5													4.0	2.5	1.5		
210	20.0	18.0	14.5	11.5													9.0	7.0													5.5	4.0	2.5	1.5	
220		20.0	17.0	13.5	11.0	8.5	7.0	5.0	3.5	2.5	1.5																								
230			20.0	16.5	13.5	11.0	8.5	7.0	5.0	4.0	2.5	1.5																							
240				20.0	19.0	15.5	13.0	10.5	8.5	6.5	5.0	4.0	2.5	1.5																					
250					20.0	18.0	15.0	12.5	10.0	8.0	6.5	5.0	3.5	2.5	1.5																				
	<i>2 rows of props</i>						<i>3 rows of props</i>																												

Slab thicknesses shaded are not recommended for exposed ceilings. The threshold varies with **Stramit Condeck HP®** Decking thicknesses for 0.75, 100 slab or less is ok, for 0.90, 180 slab or less is ok, and for 1.00, 230 slab or less is ok.

Table 8b

0.90mm STRAMIT CONDECK HP® COMPOSITE SLAB – using 25MPa concrete SINGLE SPAN – limited by strength or incremental deflection – MAXIMUM IMPOSED LIVE LOAD (kPa)																								
slab thickness (mm)	span length (mm)																							
	1800	2000	2200	2400	2600	2800	3000	3200	3400	3600	3800	4000	4200	4400	4600	4800	5000	5200	5400					
90	9.0	5.5	3.0	1.0																				
100	15.0	9.5	6.0	3.5	1.5																			
110	20.0	13.5	8.5	5.5	3.5	1.5																		
120	20.0	18.0	12.5	8.5	5.5	3.0	1.5																	
125		20.0	14.5	10.0	6.5	4.0	2.5	1.0																
130		20.0	16.5	11.5	8.0	5.0	3.0	1.5											insufficient capacity					
140			20.0	15.5	11.0	7.5	5.5	3.5	2.0	0.5														
150				19.5	14.5	10.5	7.5	5.0	3.5	2.0	0.5													
160				20.0	18.5	14.0	10.5	7.5	5.5	3.5	2.0	1.0												
	0 props			HPPlus			1 row of props																	

(mm)	3200	3400	3600	3800	4000	4200	4400	4600	4800	5000	5200	5400	5600	5800	6000	6200	6400	6600	6800						
170	10.0	7.5	5.5	3.5	2.0	1.0																			
180	12.5	9.5	7.0	5.0	3.5	2.0	1.0																		
190	16.0	12.5	9.5	7.0	5.5	3.5	2.5	1.5																	
200	19.0	15.0	12.0	9.0	7.0	5.0	3.5	2.5	1.5																
210	20.0	18.0	14.0	11.5	9.0	6.5	5.0	3.5	2.5	1.5									insufficient capacity						
220		20.0	17.0	13.5	11.0	8.5	6.5	5.0	3.5	2.5	1.0														
230			20.0	16.5	13.0	10.5	8.5	6.5	5.0	3.5	2.5	1.5													
240			20.0	19.0	15.5	12.5	10.5	8.0	6.5	5.0	3.5	2.5	1.0												
250				20.0	18.0	15.0	12.0	10.0	8.0	6.0	4.5	3.5	2.0	1.0											
	1 row of props				2 rows of props																				

Table 8c

1.00mm STRAMIT CONDECK HP® COMPOSITE SLAB – using 25MPa concrete SINGLE SPAN – limited by strength or incremental deflection – MAXIMUM IMPOSED LIVE LOAD (kPa)																					
slab thickness (mm)	span length (mm)																				
	1800	2000	2200	2400	2600	2800	3000	3200	3400	3600	3800	4000	4200	4400	4600	4800	5000	5200	5400		
90	10.0	6.0	3.5	1.5																	
100	16.5	10.5	6.5	4.0	2.0	0.5															
110	20.0	14.5	9.5	6.5	4.0	2.0	0.5														
120	20.0	19.5	13.5	9.0	6.0	3.5	2.0	0.5													
125		20.0	15.5	10.5	7.0	4.5	2.5	1.0											insufficient capacity		
130		20.0	18.0	12.5	8.5	5.5	3.5	2.0	0.5												
140			20.0	16.5	11.5	8.0	5.5	3.5	2.0	1.0											
150				20.0	15.0	11.0	8.0	5.5	3.5	2.0	1.0										
160				20.0	19.5	14.5	10.5	7.5	5.5	3.5	2.0	1.0									
	0 props			1 row of props																	

(mm)	3200	3400	3600	3800	4000	4200	4400	4600	4800	5000	5200	5400	5600	5800	6000	6200	6400	6600	6800						
170	10.0	7.5	5.5	3.5	2.0	1.0																			
180	13.0	9.5	7.0	5.0	3.5	2.0	1.0																		
190	16.0	12.5	9.5	7.0	5.5	3.5	2.5	1.0																	
200	19.5	15.0	12.0	9.0	7.0	5.0	3.5	2.0	1.5																
210	20.0	18.0	14.5	11.5	9.0	6.5	5.0	3.5	2.5	1.0									insufficient capacity						
220		20.0	17.0	13.5	11.0	8.5	6.5	5.0	3.5	2.0	1.0														
230			20.0	16.5	13.5	10.5	8.5	6.5	5.0	3.5	2.5	1.5													
240			20.0	19.0	15.5	12.5	10.5	8.0	6.5	4.5	3.5	2.0	1.0												
250				20.0	18.0	15.0	12.0	10.0	8.0	6.0	4.5	3.0	2.0	1.0											
	1 row of props				2 rows of props																				

Slab thicknesses shaded are not recommended for exposed ceilings. The threshold varies with **Stramit Condeck HP®** Decking thicknesses for 0.75, 100 slab or less is ok, for 0.90, 180 slab or less is ok, and for 1.00, 230 slab or less is ok.

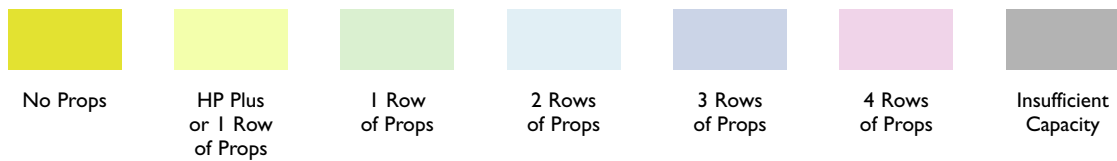
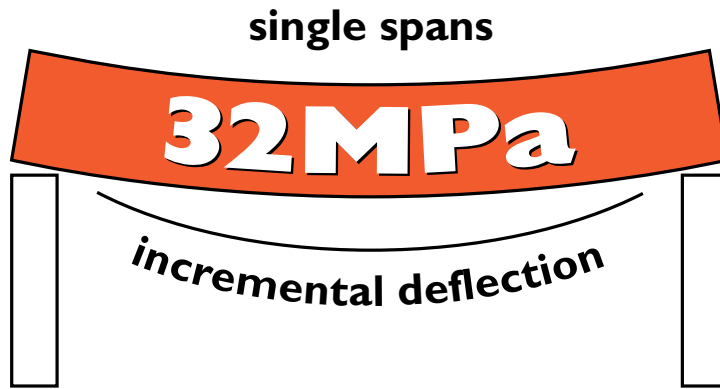

Additional notes to tables:-

The span/depth (L/D) ratio of any slab is assumed to be not less than 15.

Areas indicated as HP Plus allow the option of using 1 row of props or, utilising **Stramit Condeck HP Plus™** End Span Accessory installed as per the conditions within this manual.

All spans shown are effective spans as defined on page 4.

Refer also to the comprehensive table notes on page 12.

Table 9a

0.75mm STRAMIT CONDECK HP® COMPOSITE SLAB – using 32MPa concrete																																					
SINGLE SPAN – limited by strength or incremental deflection																																					
– MAXIMUM IMPOSED LIVE LOAD (kPa)																																					
slab thickness (mm)	span length (mm)																																				
	1800	2000	2200	2400	2600	2800	3000	3200	3400	3600	3800	4000	4200	4400	4600	4800	5000	5200	5400																		
90	8.0	4.5	2.5	0.5	insufficient capacity																																
100	14.0	9.0	6.0	3.5														2.0	0.5																		
110	20.0	13.5	9.0	6.0														4.0	2.0	1.0																	
120	20.0	19.0	13.0	9.5														6.5	4.5	2.5	1.5																
125		20.0	15.5	11.0														8.0	5.5	3.5	2.0	1.0															
130		20.0	18.0	13.0														9.5	6.5	4.5	3.0	1.5															
140			20.0	17.5														13.0	9.5	7.0	5.0	3.5	2.0	1.0													
150				20.0														16.5	12.5	9.5	7.0	5.0	3.5	2.0	1.0												
160																		20.0	20.0	16.5	12.5	9.5	7.5	5.5	4.0	2.5	1.5										
	HP Plus		1 row of props															2 rows of props																			
(mm)	3200	3400	3600	3800														4000	4200	4400	4600	4800	5000	5200	5400	5600	5800	6000	6200	6400	6600	6800					
170	12.5	9.5	7.5	5.5														4.0	2.5	1.5	insufficient capacity																
180	15.5	12.0	9.5	7.5														5.5	4.0	3.0														1.5			
190	19.0	15.0	12.0	9.5														7.5	6.0	4.5														3.0	2.0	1.0	
200	20.0	18.0	14.5	12.0														9.5	7.5	6.0														4.5	3.0	2.0	1.0
210	20.0	20.0	17.5	14.5														11.5	9.5	7.5														5.5	4.5	3.0	2.0
220		20.0	20.0	17.0	14.0	11.0	9.0	7.0	5.5	4.0	3.0	2.0	1.0																								
230			20.0	19.0	16.5	13.5	11.0	9.0	7.5	5.5	4.5	3.5	2.0	1.5																							
240				20.0	19.5	18.0	16.0	13.0	11.0	9.0	7.0	5.5	4.5	3.0	2.0	1.0																					
250					20.0	19.0	17.0	15.5	12.5	10.5	8.5	7.0	5.5	4.0	3.0	2.0	1.0																				
	2 rows of props										3 rows of props																										

Slab thicknesses shaded are not recommended for exposed ceilings. The threshold varies with **Stramit Condeck HP®** Decking thicknesses for 0.75, 100 slab or less is ok, for 0.90, 180 slab or less is ok, and for 1.00, 230 slab or less is ok.

Table 9b

**0.90mm STRAMIT CONDECK HP® COMPOSITE SLAB – using 32MPa concrete
SINGLE SPAN – limited by strength or incremental deflection
– MAXIMUM IMPOSED LIVE LOAD (kPa)**

slab thickness (mm)	span length (mm)																		
	1800	2000	2200	2400	2600	2800	3000	3200	3400	3600	3800	4000	4200	4400	4600	4800	5000	5200	5400
90	9.5	5.5	3.0	1.5															
100	16.0	10.0	6.5	4.0	2.0	0.5													
110	20.0	14.5	9.5	6.5	4.0	2.5	1.0												
120	20.0	20.0	14.0	9.5	6.5	4.5	2.5	1.0											
125		20.0	16.0	11.5	8.0	5.5	3.5	2.0	1.0										
130		20.0	18.5	13.5	9.5	6.5	4.5	3.0	1.5										
140			20.0	18.0	13.0	9.5	7.0	5.0	3.0	2.0	0.5								
150				20.0	17.0	13.0	9.5	7.0	5.0	3.5	2.0	1.0							
160				20.0	20.0	16.5	12.5	9.5	7.0	5.5	3.5	2.5	1.0						

0 props HPPlus I row of props insufficient capacity

(mm)	3200	3400	3600	3800	4000	4200	4400	4600	4800	5000	5200	5400	5600	5800	6000	6200	6400	6600	6800
170	12.5	9.5	7.0	5.5	3.5	2.5	1.5												
180	15.5	12.0	9.5	7.0	5.5	4.0	2.5	1.5											
190	19.0	15.0	12.0	9.5	7.5	5.5	4.0	3.0	1.5										
200	20.0	18.0	14.5	11.5	9.0	7.0	5.5	4.0	3.0	2.0	1.0								
210	20.0	20.0	17.5	14.0	11.5	9.0	7.0	5.5	4.0	3.0	2.0	1.0							
220		20.0	20.0	16.5	13.5	11.0	9.0	7.0	5.5	4.0	3.0	1.5							
230			20.0	19.5	16.5	13.5	11.0	9.0	7.0	5.5	4.0	3.0	2.0	1.0					
240			20.0	20.0	19.0	15.5	13.0	10.5	8.5	7.0	5.5	4.0	3.0	2.0	1.0				
250				20.0	19.5	18.0	15.0	12.5	10.5	8.5	6.5	5.0	4.0	2.5	2.0	1.0			

I row of props 2 rows of props 3 rows of props insufficient capacity

Table 9c

**1.00mm STRAMIT CONDECK HP® COMPOSITE SLAB – using 32MPa concrete
SINGLE SPAN – limited by strength or incremental deflection
– MAXIMUM IMPOSED LIVE LOAD (kPa)**

slab thickness (mm)	span length (mm)																		
	1800	2000	2200	2400	2600	2800	3000	3200	3400	3600	3800	4000	4200	4400	4600	4800	5000	5200	5400
90	11.0	6.5	3.5	1.5															
100	17.0	11.0	7.0	4.5	2.5	1.0													
110	20.0	15.5	10.5	7.0	4.5	2.5	1.0												
120	20.0	20.0	14.5	10.0	7.0	4.5	2.5	1.5											
125		20.0	17.0	12.0	8.5	5.5	3.5	2.0	1.0										
130		20.0	19.5	14.0	10.0	7.0	4.5	3.0	1.5										
140			20.0	18.5	13.5	10.0	7.0	5.0	3.0	2.0	0.5								
150				20.0	17.5	13.0	9.5	7.0	5.0	3.5	2.0	1.0							
160				20.0	20.0	17.0	13.0	9.5	7.0	5.0	3.5	2.5	1.0						

0 props I row of props insufficient capacity

(mm)	3200	3400	3600	3800	4000	4200	4400	4600	4800	5000	5200	5400	5600	5800	6000	6200	6400	6600	6800
170	12.5	9.5	7.0	5.5	3.5	2.5	1.0	0.5											
180	15.5	12.0	9.5	7.0	5.5	3.5	2.5	1.5											
190	19.0	15.0	12.0	9.5	7.0	5.5	4.0	2.5	1.5										
200	20.0	18.5	14.5	11.5	9.0	7.0	5.5	4.0	3.0	1.5									
210	20.0	20.0	17.5	14.0	11.5	9.0	7.0	5.5	4.0	2.5	1.5								
220		20.0	20.0	16.5	13.5	11.0	8.5	7.0	5.5	4.0	2.5	1.5							
230			20.0	20.0	16.5	13.5	11.0	9.0	7.0	5.5	4.0	3.0	2.0	1.0					
240			20.0	20.0	19.0	15.5	13.0	10.5	8.5	7.0	5.0	4.0	2.5	1.5					
250				20.0	20.0	18.0	15.0	12.5	10.0	8.5	6.5	5.0	4.0	2.5	1.5				

I row of props 2 rows of props insufficient capacity

Slab thicknesses shaded are not recommended for exposed ceilings. The threshold varies with **Stramit Condeck HP®** Decking thicknesses for 0.75, 100 slab or less is ok, for 0.90, 180 slab or less is ok, and for 1.00, 230 slab or less is ok.

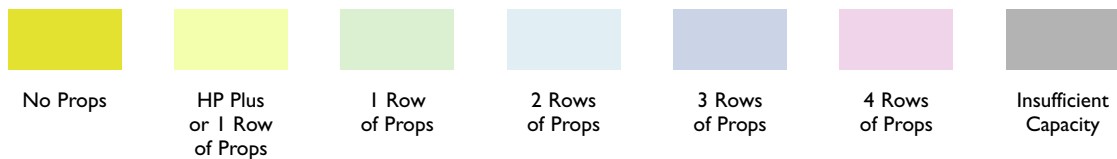
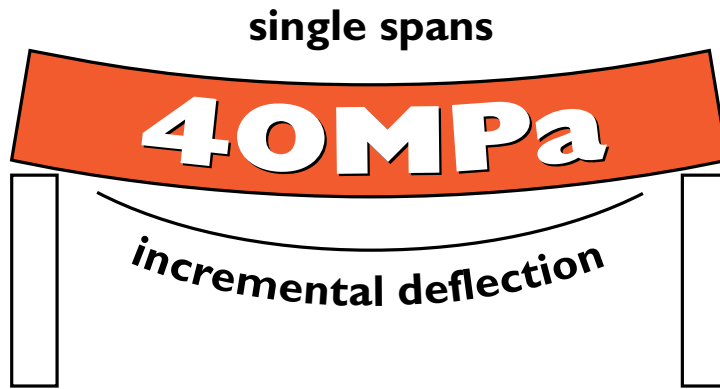

Additional notes to tables:-

The span/depth (L/D) ratio of any slab is assumed to be not less than 15.

Areas indicated as HP Plus allow the option of using 1 row of props or, utilising **Stramit Condeck HP Plus™** End Span Accessory installed as per the conditions within this manual.

All spans shown are effective spans as defined on page 4.

Refer also to the comprehensive table notes on page 12.

Table 10a

0.75mm STRAMIT CONDECK HP® COMPOSITE SLAB – using 40MPa concrete																												
SINGLE SPAN – limited by strength or incremental deflection																												
– MAXIMUM IMPOSED LIVE LOAD (kPa)																												
slab thickness (mm)	span length (mm)																											
	1800	2000	2200	2400	2600	2800	3000	3200	3400	3600	3800	4000	4200	4400	4600	4800	5000	5200	5400									
90	9.0	5.0	3.0	1.5	insufficient capacity																							
100	16.5	11.0	7.5	5.0														3.0	1.5									
110	20.0	16.0	11.5	8.0														5.5	3.5	2.0	1.0							
120	20.0	20.0	16.0	11.5														8.5	6.0	4.0	2.5	1.5						
125	20.0	20.0	18.5	13.5														10.0	7.0	5.0	3.5	2.0	1.0					
130	20.0	20.0	20.0	15.5														11.5	8.5	6.5	4.5	3.0	2.0	1.0				
140	20.0	20.0	20.0	20.0														15.5	12.0	9.0	6.5	5.0	3.5	2.0	1.0			
150	20.0	20.0	20.0	20.0														20.0	15.5	12.0	9.0	7.0	5.0	3.5	2.5	1.5		
160	20.0	20.0	20.0	20.0														19.5	15.5	12.0	9.5	7.0	5.5	4.0	3.0	1.5		
HPPlus		1 row of props																2 rows of props										
(mm)	3200	3400	3600	3800	4000	4200	4400	4600	4800	5000	5200	5400	5600	5800	6000	6200	6400	6600	6800									
170	15.0	12.0	9.5	7.5	5.5	4.0	3.0	2.0	1.0	insufficient capacity																		
180	18.5	14.5	12.0	9.5	7.5	5.5	4.5	3.0	2.0											1.0								
190	20.0	18.0	14.5	12.0	9.5	7.5	6.0	4.5	3.5											2.5	1.5							
200	20.0	20.0	17.5	14.5	12.0	9.5	7.5	6.0	4.5											3.5	2.5	1.5						
210	20.0	20.0	19.0	17.0	14.0	11.5	9.5	7.5	6.0											4.5	3.5	2.5	1.5					
220	20.0	20.0	20.0	18.0	16.5	14.0	11.5	9.5	7.5											6.0	4.5	3.5	2.5	1.5				
230	20.0	20.0	20.0	19.0	17.5	16.0	13.5	11.5	9.5											7.5	6.0	5.0	3.5	2.5	1.5			
240	20.0	20.0	20.0	20.0	18.0	16.5	15.0	13.5	11.0											9.0	7.5	6.0	5.0	3.5	2.5	1.5		
250	20.0	20.0	20.0	20.0	19.0	17.5	16.0	14.5	13.0											11.0	9.0	7.5	6.0	4.5	3.5	2.5	1.5	
2 rows of props					3 rows of props																							

Slab thicknesses shaded are not recommended for exposed ceilings. The threshold varies with **Stramit Condeck HP®** Decking thicknesses for 0.75, 100 slab or less is ok, for 0.90, 180 slab or less is ok, and for 1.00, 230 slab or less is ok.

Table 10b

0.90mm STRAMIT CONDECK HP® COMPOSITE SLAB – using 40MPa concrete SINGLE SPAN – limited by strength or incremental deflection – MAXIMUM IMPOSED LIVE LOAD (kPa)																				
slab thickness (mm)	span length (mm)																			
	1800	2000	2200	2400	2600	2800	3000	3200	3400	3600	3800	4000	4200	4400	4600	4800	5000	5200	5400	
90	10.0	6.0	3.5	1.5																
100	17.5	11.5	7.5	5.0	3.0	1.5														
110	20.0	16.5	11.5	8.0	5.5	3.5	2.0	1.0												
120	20.0	20.0	16.0	11.5	8.5	6.0	4.0	2.5	1.0											
125		20.0	18.5	13.5	10.0	7.0	5.0	3.5	2.0	1.0										
130		20.0	20.0	16.0	11.5	8.5	6.0	4.0	3.0	1.5									insufficient capacity	
140			20.0	20.0	15.5	12.0	9.0	6.5	4.5	3.0	2.0	1.0								
150				20.0	20.0	15.5	11.5	9.0	6.5	5.0	3.5	2.0	1.0							
160				20.0	20.0	19.5	15.0	12.0	9.0	7.0	5.0	3.5	2.5	1.5						
	0 props			HPPlus			1 row of props													

(mm)	3200	3400	3600	3800	4000	4200	4400	4600	4800	5000	5200	5400	5600	5800	6000	6200	6400	6600	6800	
170	15.0	12.0	9.0	7.0	5.5	4.0	2.5	1.5												
180	18.0	14.5	11.5	9.0	7.0	5.5	4.0	3.0	2.0	1.0										
190	20.0	18.0	14.5	11.5	9.5	7.5	5.5	4.5	3.0	2.0	1.0									
200	20.0	20.0	17.5	14.0	11.5	9.0	7.5	6.0	4.5	3.0	2.0	1.0							insufficient capacity	
210	20.0	20.0	20.0	17.0	14.0	11.0	9.0	7.5	6.0	4.5	3.0	2.0	1.0							
220		20.0	20.0	19.0	16.5	13.5	11.0	9.0	7.5	5.5	4.5	3.0	2.0	1.0						
230			20.0	19.5	18.0	16.0	13.5	11.0	9.0	7.5	6.0	4.5	3.5	2.5	1.5					
240			20.0	20.0	19.0	17.5	15.5	13.0	11.0	9.0	7.0	5.5	4.5	3.0	2.5	1.5				
250				20.0	19.5	18.0	16.5	15.0	12.5	10.5	8.5	7.0	5.5	4.5	3.5	2.5	1.5			
	1 row of props				2 rows of props								3 rows of props							

Table 10c

1.00mm STRAMIT CONDECK HP® COMPOSITE SLAB – using 40MPa concrete SINGLE SPAN – limited by strength or incremental deflection – MAXIMUM IMPOSED LIVE LOAD (kPa)																				
slab thickness (mm)	span length (mm)																			
	1800	2000	2200	2400	2600	2800	3000	3200	3400	3600	3800	4000	4200	4400	4600	4800	5000	5200	5400	
90	11.5	7.0	4.0	2.0	0.5															
100	18.5	12.0	8.0	5.0	3.0	1.5														
110	20.0	17.5	12.0	8.0	5.5	3.5	2.0	1.0												
120	20.0	20.0	16.5	12.0	8.5	6.0	4.0	2.5	1.0											
125		20.0	19.0	14.0	10.0	7.0	5.0	3.0	2.0	1.0									insufficient capacity	
130		20.0	20.0	16.0	12.0	8.5	6.0	4.0	2.5	1.5										
140			20.0	20.0	16.0	12.0	9.0	6.5	4.5	3.0	2.0	1.0								
150				20.0	20.0	15.5	12.0	9.0	6.5	5.0	3.5	2.0	1.0							
160				20.0	20.0	19.5	15.5	12.0	9.0	7.0	5.0	3.5	2.5	1.5						
	0 props			1 row of props																

(mm)	3200	3400	3600	3800	4000	4200	4400	4600	4800	5000	5200	5400	5600	5800	6000	6200	6400	6600	6800	
170	15.0	11.5	9.0	7.0	5.5	4.0	2.5	1.5												
180	18.5	14.5	11.5	9.0	7.0	5.5	4.0	2.5	1.5											
190	20.0	18.0	14.5	11.5	9.5	7.0	5.5	4.0	3.0											
200	20.0	20.0	17.5	14.0	11.5	9.0	7.0	5.5	4.5	3.0	2.0	1.0							insufficient capacity	
210	20.0	20.0	20.0	17.0	14.0	11.0	9.0	7.0	5.5	4.5	3.0	2.0	1.0							
220		20.0	20.0	19.5	16.5	13.5	11.0	9.0	7.0	5.5	4.5	3.0	2.0	1.0						
230			20.0	20.0	18.5	16.0	13.5	11.0	9.0	7.5	5.5	4.5	3.0	2.0	1.0					
240			20.0	20.0	19.5	17.5	15.5	13.0	11.0	9.0	7.0	5.5	4.5	3.0	2.0	1.0				
250				20.0	20.0	18.5	17.0	15.0	12.5	10.5	8.5	7.0	5.5	4.0	3.0	2.0	1.5			
	1 row of props				2 rows of props								3 rows of props							

Slab thicknesses shaded are not recommended for exposed ceilings. The threshold varies with **Stramit Condeck HP®** Decking thicknesses for 0.75, 100 slab or less is ok, for 0.90, 180 slab or less is ok, and for 1.00, 230 slab or less is ok.

continuous spans



Additional notes to tables:-

The span/depth (L/D) ratio of any slab is assumed to be not less than 15.

Areas indicated as HP Plus allow the option of using 1 row of props or, utilising **Stramit Condeck HP Plus™** End Span Accessory installed as per the conditions within this manual.

All spans shown are effective end spans as defined on page 4.

Refer also to the comprehensive table notes on page 12.

Internal span can be increased by up to 20%.

Table 11a

0.75mm STRAMIT CONDECK HP® COMPOSITE SLAB – using 25MPa concrete CONTINUOUS SPAN – limited by strength or total deflection – MAXIMUM IMPOSED LIVE LOAD (kPa)																			
slab thickness (mm)	span length (mm)																		
	1800	2000	2200	2400	2600	2800	3000	3200	3400	3600	3800	4000	4200	4400	4600	4800	5000	5200	5400
90	20.0	16.5	11.0	7.5	5.5	3.5	2.5	1.0	insufficient capacity										
100	20.0	20.0	16.5	12.0	8.5	6.0	4.0	2.5	1.5	insufficient capacity									
110	20.0	20.0	20.0	17.0	12.0	8.5	6.5	4.5	3.0	2.0	1.0	insufficient capacity							
120	20.0	20.0	20.0	20.0	17.0	12.5	9.0	6.5	5.0	3.5	2.0	1.5	insufficient capacity						
125		20.0	20.0	20.0	20.0	14.5	11.0	8.0	6.0	4.5	3.0	2.0	1.0	insufficient capacity					
130		20.0	20.0	20.0	20.0	17.0	13.0	9.5	7.0	5.5	4.0	2.5	1.5	insufficient capacity					
	0 props			HP Plus		1 row of props													
(mm)	3000	3200	3400	3600	3800	4000	4200	4400	4600	4800	5000	5200	5400	5600	5800	6000	6200	6400	6600
140	17.5	13.5	10.0	7.5	6.0	4.5	3.0	2.0	1.0	insufficient capacity									
150	20.0	17.5	13.5	10.5	8.0	6.0	4.5	3.5	2.5	1.5	insufficient capacity								
160	20.0	20.0	17.5	14.0	11.0	8.5	7.0	5.0	4.0	3.0	2.0	1.0	insufficient capacity						
170	20.0	20.0	20.0	17.5	14.0	11.0	9.0	7.0	5.5	4.0	3.0	2.0	1.0	insufficient capacity					
180	20.0	20.0	20.0	20.0	17.5	14.0	11.5	9.0	7.5	6.0	4.5	3.5	2.0	1.5	insufficient capacity				
190	20.0	20.0	20.0	20.0	19.0	17.5	14.5	12.0	9.5	8.0	6.5	5.0	3.5	2.5	1.5	insufficient capacity			
	1 row of props					2 rows of props													
(mm)	4400	4600	4800	5000	5200	5400	5600	5800	6000	6200	6400	6600	6800	7000	7200	7400	7600	7800	8000
200	14.5	12.0	10.0	8.0	6.5	5.0	4.0	2.5	2.0	1.0	insufficient capacity								
210	16.5	14.5	12.0	10.0	8.0	6.5	5.0	4.0	3.0	2.0	1.0	insufficient capacity							
220	17.5	16.0	14.5	12.0	10.0	8.0	6.5	5.0	4.0	3.0	2.0	1.0	insufficient capacity						
230	18.0	17.0	15.5	14.5	12.5	10.5	8.5	7.0	5.5	4.5	3.0	2.0	1.5	insufficient capacity					
240	19.0	17.5	16.5	15.0	14.0	12.5	10.5	8.5	7.0	5.5	4.5	3.0	2.0	1.5	insufficient capacity				
250	20.0	18.5	17.0	16.0	15.0	14.0	12.5	10.5	8.5	7.0	5.5	4.5	3.0	2.0	1.5	insufficient capacity			
	2 rows of props				3 rows of props							4 rows of props							

Slab thicknesses shaded are not recommended for exposed ceilings. The threshold varies with **Stramit Condeck HP®** Decking thicknesses for 0.75, 100 slab or less is ok, for 0.90, 180 slab or less is ok, and for 1.00, 230 slab or less is ok.

Table I Ib

0.90mm STRAMIT CONDECK HP® COMPOSITE SLAB – using 25MPa concrete CONTINUOUS SPAN – limited by strength or total deflection – MAXIMUM IMPOSED LIVE LOAD (kPa)																					
slab thickness (mm)	span length (mm)																				
	1800	2000	2200	2400	2600	2800	3000	3200	3400	3600	3800	4000	4200	4400	4600	4800	5000	5200	5400		
90	20.0	18.5	12.5	8.5	5.5	4.0	2.5	1.5													
100	20.0	20.0	18.5	12.5	9.0	6.5	4.5	3.0	1.5												
110	20.0	20.0	20.0	18.5	13.5	9.5	7.0	4.5	3.0	2.0	1.0										
120	20.0	20.0	20.0	20.0	19.0	13.5	10.0	7.0	5.0	3.5	2.5	1.5								insufficient capacity	
125		20.0	20.0	20.0	20.0	16.0	11.5	8.5	6.5	4.5	3.0	2.0	1.0								
130		20.0	20.0	20.0	20.0	18.5	13.5	10.0	7.5	5.5	4.0	2.5	1.5								
	0 props				HPPlus		1 row of props														

(mm)	3000	3200	3400	3600	3800	4000	4200	4400	4600	4800	5000	5200	5400	5600	5800	6000	6200	6400	6600	
140	19.0	14.0	10.5	8.0	6.0	4.5	3.0	2.0	1.0											
150	20.0	18.5	14.0	11.0	8.5	6.5	4.5	3.5	2.0	1.5										
160	20.0	20.0	18.5	14.5	11.5	9.0	6.5	5.0	3.5	3.0	2.0	1.0								
170	20.0	20.0	20.0	18.5	14.5	11.5	9.0	7.0	5.5	4.0	3.0	2.0	1.0							insufficient capacity
180	20.0	20.0	20.0	20.0	18.0	14.5	11.5	9.0	7.5	6.0	4.5	3.0	2.0	1.5						
190	20.0	20.0	20.0	20.0	20.0	18.5	15.0	12.0	10.0	8.0	6.0	5.0	3.5	2.5	1.5					
	1 row of props								2 rows of props											

(mm)	4400	4600	4800	5000	5200	5400	5600	5800	6000	6200	6400	6600	6800	7000	7200	7400	7600	7800	8000	
200	15.0	12.0	10.0	8.0	6.5	5.0	3.5	2.5	1.5											
210	17.5	15.0	12.0	10.0	8.0	6.5	5.0	4.0	3.0	2.0	1.0									
220	18.0	17.0	15.0	12.0	10.0	8.0	6.5	5.0	4.0	3.0	2.0	1.0								
230	19.0	17.5	16.5	15.0	12.5	10.5	8.5	7.0	5.5	4.0	3.0	2.0	1.0							insufficient capacity
240	20.0	18.5	17.0	16.0	14.5	12.5	10.5	8.5	7.0	5.5	4.0	3.0	2.0	1.0						
250	20.0	19.0	18.0	16.5	15.5	14.5	12.5	10.5	8.5	7.0	5.5	4.0	3.0	2.0	1.0					
	2 rows of props								3 rows of props											

Table I Ic

1.00mm STRAMIT CONDECK HP® COMPOSITE SLAB – using 25MPa concrete CONTINUOUS SPAN – limited by strength or total deflection – MAXIMUM IMPOSED LIVE LOAD (kPa)																					
slab thickness (mm)	span length (mm)																				
	1800	2000	2200	2400	2600	2800	3000	3200	3400	3600	3800	4000	4200	4400	4600	4800	5000	5200	5400		
90	20.0	20.0	13.5	9.0	6.0	4.0	2.5	1.5													
100	20.0	20.0	20.0	13.5	9.5	6.5	4.5	3.0	2.0	1.0											
110	20.0	20.0	20.0	20.0	14.0	10.0	7.0	5.0	3.5	2.0	1.0										
120	20.0	20.0	20.0	20.0	19.5	14.5	10.5	7.5	5.5	3.5	2.5	1.5								insufficient capacity	
125		20.0	20.0	20.0	20.0	17.0	12.5	9.0	6.5	4.5	3.0	2.0	1.0								
130		20.0	20.0	20.0	20.0	20.0	14.5	10.5	8.0	5.5	4.0	2.5	1.5								
	0 props				HPPlus		1 row of props														

(mm)	3000	3200	3400	3600	3800	4000	4200	4400	4600	4800	5000	5200	5400	5600	5800	6000	6200	6400	6600	
140	20.0	15.0	11.0	8.5	6.0	4.5	3.0	2.0	1.0											
150	20.0	19.5	15.0	11.5	8.5	6.5	5.0	3.5	2.5	1.5										
160	20.0	20.0	19.5	15.0	11.5	9.0	7.0	5.0	4.0	2.5	2.0	1.0								insufficient capacity
170	20.0	20.0	20.0	19.5	15.0	12.0	9.0	7.0	5.5	4.0	3.0	2.0	1.0							
180	20.0	20.0	20.0	20.0	19.0	15.0	12.0	9.5	7.5	6.0	4.5	3.0	2.0	1.5						
190	20.0	20.0	20.0	20.0	20.0	19.0	15.0	12.0	9.5	8.0	6.0	5.0	3.5	2.5	1.5					
	1 row of props								2 rows of props											

(mm)	4400	4600	4800	5000	5200	5400	5600	5800	6000	6200	6400	6600	6800	7000	7200	7400	7600	7800	8000	
200	15.0	12.5	10.0	8.0	6.5	5.0	4.0	2.5	1.5											
210	17.5	15.0	12.5	10.0	8.0	6.5	5.0	4.0	3.0	2.0	1.0									
220	18.5	17.5	15.0	12.5	10.0	8.0	6.5	5.0	4.0	3.0	2.0	1.0								
230	19.5	18.0	16.5	15.0	12.5	10.5	8.5	7.0	5.5	4.0	3.0	2.0	1.0							insufficient capacity
240	20.0	19.0	17.5	16.5	15.0	12.5	10.5	8.5	7.0	5.5	4.0	3.0	2.0	1.0						
250	20.0	19.5	18.0	17.0	16.0	14.5	12.5	10.5	8.5	7.0	5.5	4.0	3.0	2.0	1.0					
	2 rows of props								3 rows of props											

Slab thicknesses shaded are not recommended for exposed ceilings. The threshold varies with **Stramit Condeck HP®** Decking thicknesses for 0.75, 100 slab or less is ok, for 0.90, 180 slab or less is ok, and for 1.00, 230 slab or less is ok.

continuous spans

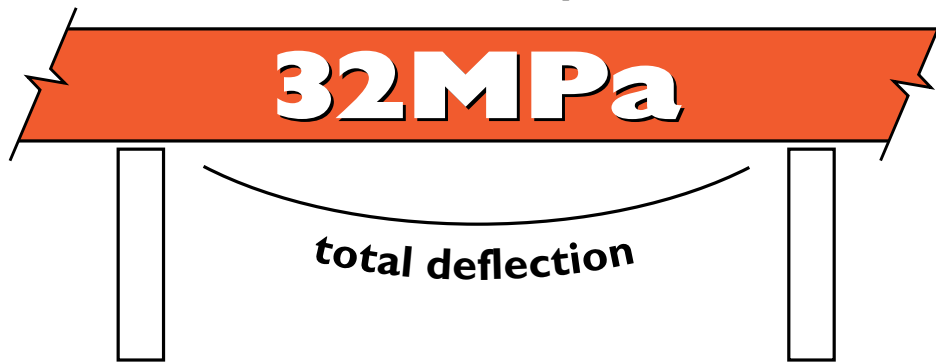

Additional notes to tables:-

The span/depth (L/D) ratio of any slab is assumed to be not less than 15.

Areas indicated as HP Plus allow the option of using 1 row of props or, utilising **Stramit Condeck HP Plus™** End Span Accessory installed as per the conditions within this manual.

All spans shown are effective end spans as defined on page 4.

Refer also to the comprehensive table notes on page 12.

Internal span can be increased by up to 20%.

Table 12a

0.75mm STRAMIT CONDECK HP® COMPOSITE SLAB – using 32MPa concrete CONTINUOUS SPAN – limited by strength or total deflection – MAXIMUM IMPOSED LIVE LOAD (kPa)																				
slab thickness (mm)	span length (mm)																			
	1800	2000	2200	2400	2600	2800	3000	3200	3400	3600	3800	4000	4200	4400	4600	4800	5000	5200	5400	
90	20.0	18.5	12.5	9.0	6.5	4.5	3.0	2.0	1.0	insufficient capacity										
100	20.0	20.0	19.0	13.5	10.0	7.0	5.0	3.5	2.5										1.5	
110	20.0	20.0	20.0	19.5	14.5	10.5	8.0	6.0	4.0	3.0	2.0	1.0	insufficient capacity							
120	20.0	20.0	20.0	20.0	20.0	15.0	11.0	8.5	6.5	4.5	3.5	2.5							1.5	
125		20.0	20.0	20.0	20.0	17.5	13.0	10.0	7.5	6.0	4.5	3.0	2.0	1.0	insufficient capacity					
130		20.0	20.0	20.0	20.0	20.0	15.5	12.0	9.0	7.0	5.5	4.0	3.0	2.0						
	0 props			HP Plus		1 row of props											2 rows of props		insufficient capacity	
(mm)	3000	3200	3400	3600	3800	4000	4200	4400	4600	4800	5000	5200	5400	5600	5800	6000	6200	6400	6600	
140	20.0	16.0	12.5	10.0	7.5	6.0	4.5	3.5	2.5	1.5	insufficient capacity									
150	20.0	20.0	16.5	13.0	10.0	8.0	6.5	5.0	4.0	2.5										2.0
160	20.0	20.0	19.5	17.0	13.5	11.0	9.0	7.0	5.5	4.5	3.0	2.0	1.5	insufficient capacity						
170	20.0	20.0	20.0	19.0	17.0	14.0	11.5	9.0	7.5	6.0	4.5	3.5	2.5							1.5
180	20.0	20.0	20.0	20.0	18.5	17.0	14.0	11.5	9.5	8.0	6.0	5.0	3.5	2.5	2.0	insufficient capacity				
190	20.0	20.0	20.0	20.0	19.0	17.5	16.5	15.0	12.0	10.0	8.5	6.5	5.5	4.0	3.0					
	1 row of props					2 rows of props										3 rows of props				
(mm)	4400	4600	4800	5000	5200	5400	5600	5800	6000	6200	6400	6600	6800	7000	7200	7400	7600	7800	8000	
200	16.0	14.5	12.5	10.5	8.5	7.0	5.5	4.5	3.5	2.5	1.5	insufficient capacity								
210	16.5	15.5	14.5	12.5	10.5	8.5	7.0	5.5	4.5	3.5	2.5									1.5
220	17.5	16.0	15.0	14.0	12.5	10.5	9.0	7.5	6.0	4.5	3.5	2.5	1.5	insufficient capacity						
230	18.5	17.0	15.5	14.5	13.5	12.5	11.0	9.5	7.5	6.0	5.0	4.0	3.0							2.0
240	19.0	17.5	16.5	15.5	14.0	13.5	12.5	11.0	9.5	7.5	6.5	5.0	4.0	3.0	2.0	1.0	insufficient capacity			
250	20.0	18.5	17.0	16.0	15.0	14.0	13.0	12.0	11.0	9.5	8.0	6.5	5.0	4.0	3.0	2.0				1.0
	2 rows of props				3 rows of props								4 rows of props							

Slab thicknesses shaded are not recommended for exposed ceilings. The threshold varies with **Stramit Condeck HP®** Decking thicknesses for 0.75, 100 slab or less is ok, for 0.90, 180 slab or less is ok, and for 1.00, 230 slab or less is ok.

Table 12b

0.90mm STRAMIT CONDECK HP® COMPOSITE SLAB – using 32MPa concrete CONTINUOUS SPAN – limited by strength or total deflection – MAXIMUM IMPOSED LIVE LOAD (kPa)																				
slab thickness (mm)	span length (mm)																			
	1800	2000	2200	2400	2600	2800	3000	3200	3400	3600	3800	4000	4200	4400	4600	4800	5000	5200	5400	
90	20.0	20.0	14.0	9.5	6.5	5.0	3.0	2.0	1.0	insufficient capacity										
100	20.0	20.0	20.0	14.5	10.5	7.5	5.5	3.5	2.5	1.5	insufficient capacity									
110	20.0	20.0	20.0	20.0	15.5	11.0	8.0	6.0	4.5	3.0	2.0	1.0	insufficient capacity							
120	20.0	20.0	20.0	20.0	20.0	16.0	11.5	9.0	6.5	5.0	3.5	2.5	1.5	insufficient capacity						
125		20.0	20.0	20.0	20.0	18.5	14.0	10.5	8.0	6.0	4.5	3.0	2.0	1.0	insufficient capacity					
130		20.0	20.0	20.0	20.0	20.0	16.0	12.0	9.5	7.0	5.5	4.0	2.5	2.0	1.0	insufficient capacity				
	0 props				HPPlus		1 row of props													
(mm)	3000	3200	3400	3600	3800	4000	4200	4400	4600	4800	5000	5200	5400	5600	5800	6000	6200	6400	6600	
140	20.0	16.5	13.0	10.0	7.5	6.0	4.5	3.0	2.0	1.5	insufficient capacity									
150	20.0	20.0	17.0	13.0	10.5	8.0	6.5	5.0	3.5	2.5	2.0	1.0	insufficient capacity							
160	20.0	20.0	20.0	17.5	14.0	11.0	8.5	7.0	5.5	4.0	3.0	2.0	1.5	insufficient capacity						
170	20.0	20.0	20.0	20.0	17.5	14.0	11.5	9.0	7.5	6.0	4.5	3.5	2.5	1.5	insufficient capacity					
180	20.0	20.0	20.0	20.0	19.5	17.5	14.0	11.5	9.5	8.0	6.0	5.0	3.5	2.5	2.0	1.0	insufficient capacity			
190	20.0	20.0	20.0	20.0	20.0	18.5	17.0	15.0	12.5	10.0	8.5	6.5	5.5	4.0	3.0	2.0	1.5	insufficient capacity		
	1 row of props							2 rows of props												
(mm)	4400	4600	4800	5000	5200	5400	5600	5800	6000	6200	6400	6600	6800	7000	7200	7400	7600	7800	8000	
200	16.5	15.0	12.5	10.5	8.5	7.0	5.5	4.5	3.0	2.5	1.5	insufficient capacity								
210	17.5	16.0	15.0	12.5	10.5	8.5	7.0	5.5	4.5	3.5	2.5	1.5	insufficient capacity							
220	18.5	17.0	15.5	14.5	12.5	10.5	9.0	7.5	6.0	4.5	3.5	2.5	1.5	insufficient capacity						
230	19.0	17.5	16.5	15.5	14.0	13.0	11.0	9.0	7.5	6.0	5.0	4.0	3.0	2.0	1.0	insufficient capacity				
240	20.0	18.5	17.0	16.0	15.0	14.0	13.0	11.0	9.5	7.5	6.0	5.0	4.0	3.0	2.0	1.0	insufficient capacity			
250	20.0	19.5	18.0	16.5	15.5	14.5	13.5	12.5	11.0	9.5	7.5	6.5	5.0	4.0	3.0	2.0	1.0	insufficient capacity		
	2 rows of props										3 rows of props									

Table 12c

1.00mm STRAMIT CONDECK HP® COMPOSITE SLAB – using 32MPa concrete CONTINUOUS SPAN – limited by strength or total deflection – MAXIMUM IMPOSED LIVE LOAD (kPa)																				
slab thickness (mm)	span length (mm)																			
	1800	2000	2200	2400	2600	2800	3000	3200	3400	3600	3800	4000	4200	4400	4600	4800	5000	5200	5400	
90	20.0	20.0	15.0	10.0	7.0	4.5	3.5	2.0	1.0	insufficient capacity										
100	20.0	20.0	20.0	15.5	10.5	8.0	5.5	4.0	2.5	1.5	insufficient capacity									
110	20.0	20.0	20.0	20.0	15.5	11.5	8.5	6.0	4.5	3.0	2.0	1.0	insufficient capacity							
120	20.0	20.0	20.0	20.0	20.0	16.5	12.5	9.0	7.0	5.0	3.5	2.5	1.5	insufficient capacity						
125		20.0	20.0	20.0	20.0	19.5	14.5	11.0	8.0	6.0	4.5	3.0	2.0	1.0	insufficient capacity					
130		20.0	20.0	20.0	20.0	20.0	17.0	12.5	9.5	7.5	5.5	4.0	3.0	2.0	1.0	insufficient capacity				
	0 props				HPPlus		1 row of props													
(mm)	3000	3200	3400	3600	3800	4000	4200	4400	4600	4800	5000	5200	5400	5600	5800	6000	6200	6400	6600	
140	20.0	17.0	13.5	10.0	8.0	6.0	4.5	3.0	2.0	1.5	insufficient capacity									
150	20.0	20.0	17.5	13.5	10.5	8.5	6.5	5.0	3.5	2.5	2.0	1.0	insufficient capacity							
160	20.0	20.0	20.0	18.0	14.0	11.0	9.0	7.0	5.5	4.0	3.0	2.0	1.5	insufficient capacity						
170	20.0	20.0	20.0	20.0	18.0	14.5	11.5	9.0	7.5	6.0	4.5	3.5	2.5	1.5	insufficient capacity					
180	20.0	20.0	20.0	20.0	20.0	18.0	14.5	11.5	9.5	8.0	6.0	5.0	3.5	2.5	1.5	insufficient capacity				
190	20.0	20.0	20.0	20.0	20.0	19.0	17.5	15.0	12.0	10.0	8.5	6.5	5.5	4.0	3.0	2.0	1.0	insufficient capacity		
	1 row of props							2 rows of props												
(mm)	4400	4600	4800	5000	5200	5400	5600	5800	6000	6200	6400	6600	6800	7000	7200	7400	7600	7800	8000	
200	17.0	15.0	12.5	10.5	8.5	7.0	5.5	4.5	3.0	2.0	1.5	insufficient capacity								
210	18.0	16.5	15.5	12.5	10.5	8.5	7.0	5.5	4.5	3.5	2.5	1.5	insufficient capacity							
220	18.5	17.5	16.0	15.0	13.0	10.5	9.0	7.5	6.0	4.5	3.5	2.5	1.5	insufficient capacity						
230	19.5	18.0	17.0	15.5	14.5	13.0	11.0	9.0	7.5	6.0	5.0	4.0	3.0	2.0	1.0	insufficient capacity				
240	20.0	19.0	17.5	16.5	15.5	14.0	13.0	11.0	9.5	7.5	6.5	5.0	4.0	3.0	2.0	1.0	insufficient capacity			
250	20.0	20.0	18.5	17.0	16.0	15.0	14.0	13.0	11.0	9.5	8.0	6.5	5.0	4.0	3.0	2.0	1.0	insufficient capacity		
	2 rows of props										3 rows of props									

Slab thicknesses shaded are not recommended for exposed ceilings. The threshold varies with **Stramit Condeck HP®** Decking thicknesses for 0.75, 100 slab or less is ok, for 0.90, 180 slab or less is ok, and for 1.00, 230 slab or less is ok.

continuous spans



Additional notes to tables:-

The span/depth (L/D) ratio of any slab is assumed to be not less than 15.

Areas indicated as HP Plus allow the option of using 1 row of props or, utilising **Stramit Condeck HP Plus™** End Span Accessory installed as per the conditions within this manual.

All spans shown are effective end spans as defined on page 4.

Refer also to the comprehensive table notes on page 12.

Internal span can be increased by up to 20%.

Table 13a

0.75mm STRAMIT CONDECK HP® COMPOSITE SLAB – using 40MPa concrete CONTINUOUS SPAN – limited by strength or total deflection – MAXIMUM IMPOSED LIVE LOAD (kPa)																			
slab thickness (mm)	span length (mm)																		
	1800	2000	2200	2400	2600	2800	3000	3200	3400	3600	3800	4000	4200	4400	4600	4800	5000	5200	5400
90	20.0	20.0	14.5	10.0	7.5	5.5	4.0	2.5	1.5	insufficient capacity									
100	20.0	20.0	20.0	16.0	12.0	9.0	6.5	5.0	3.5	2.5	1.5	insufficient capacity							
110	20.0	20.0	20.0	20.0	17.0	13.0	9.5	7.5	5.5	4.0	3.0	2.0	1.0	insufficient capacity					
120	20.0	20.0	20.0	20.0	20.0	17.5	13.5	10.5	8.0	6.5	5.0	3.5	2.5	1.5	1.0	insufficient capacity			
125		20.0	20.0	20.0	20.0	20.0	16.0	12.5	9.5	7.5	6.0	4.5	3.0	2.0	1.5	insufficient capacity			
130		20.0	20.0	20.0	20.0	20.0	18.5	14.5	11.5	9.0	7.0	5.5	4.0	3.0	2.0	1.5	insufficient capacity		
	0 props			HP Plus		1 row of props								2 rows of props			insufficient capacity		
(mm)	3000	3200	3400	3600	3800	4000	4200	4400	4600	4800	5000	5200	5400	5600	5800	6000	6200	6400	6600
140	20.0	19.0	15.0	12.0	9.5	7.5	6.0	5.0	3.5	2.5	2.0	1.0	insufficient capacity						
150	20.0	20.0	18.5	15.5	12.5	10.0	8.0	6.5	5.5	4.0	3.0	2.0	1.5	insufficient capacity					
160	20.0	20.0	20.0	18.0	16.5	13.5	11.0	9.0	7.5	6.0	4.5	3.5	2.5	1.5	1.0	insufficient capacity			
170	20.0	20.0	20.0	19.0	17.5	16.0	14.0	11.5	9.5	8.0	6.5	5.0	4.0	3.0	2.0	1.5	insufficient capacity		
180	20.0	20.0	20.0	20.0	18.5	17.0	15.5	14.5	12.0	10.0	8.0	6.5	5.5	4.0	3.0	2.5	1.5	insufficient capacity	
190	20.0	20.0	20.0	20.0	19.5	18.0	16.5	15.0	14.0	12.5	10.5	9.0	7.0	6.0	4.5	3.5	2.5	2.0	1.0
	1 row of props					2 rows of props										3 rows of props			
(mm)	4400	4600	4800	5000	5200	5400	5600	5800	6000	6200	6400	6600	6800	7000	7200	7400	7600	7800	8000
200	16.0	14.5	13.5	12.5	11.0	9.0	7.5	6.0	5.0	4.0	3.0	2.0	1.5	insufficient capacity					
210	16.5	15.5	14.5	13.5	12.5	11.0	9.5	7.5	6.5	5.0	4.0	3.0	2.0	1.5	insufficient capacity				
220	17.5	16.0	15.0	14.0	13.0	12.0	11.5	9.5	8.0	6.5	5.5	4.0	3.0	2.5	1.5	insufficient capacity			
230	18.5	17.0	16.0	14.5	13.5	12.5	12.0	11.0	10.0	8.5	7.0	5.5	4.5	3.5	2.5	1.5	insufficient capacity		
240	19.0	18.0	16.5	15.5	14.5	13.5	12.5	11.5	11.0	10.0	8.5	7.0	6.0	4.5	3.5	2.5	2.0	1.0	insufficient capacity
250	20.0	18.5	17.5	16.0	15.0	14.0	13.0	12.0	11.5	10.5	10.0	8.5	7.0	6.0	4.5	3.5	2.5	2.0	1.0
	2 rows of props				3 rows of props								4 rows of props						

Slab thicknesses shaded are not recommended for exposed ceilings. The threshold varies with **Stramit Condeck HP®** Decking thicknesses for 0.75, 100 slab or less is ok, for 0.90, 180 slab or less is ok, and for 1.00, 230 slab or less is ok.

Table 13b

0.90mm STRAMIT CONDECK HP® COMPOSITE SLAB – using 40MPa concrete CONTINUOUS SPAN – limited by strength or total deflection – MAXIMUM IMPOSED LIVE LOAD (kPa)																				
slab thickness (mm)	span length (mm)																			
	1800	2000	2200	2400	2600	2800	3000	3200	3400	3600	3800	4000	4200	4400	4600	4800	5000	5200	5400	
90	20.0	20.0	15.5	11.0	7.5	5.5	4.0	2.5	1.5	insufficient capacity										
100	20.0	20.0	20.0	16.5	12.5	9.0	6.5	5.0	3.5	2.5	1.5	insufficient capacity								
110	20.0	20.0	20.0	20.0	18.0	13.5	10.0	7.5	5.5	4.0	3.0	2.0	1.0	insufficient capacity						
120	20.0	20.0	20.0	20.0	20.0	18.5	14.0	11.0	8.5	6.5	5.0	3.5	2.5	1.5	insufficient capacity					
125		20.0	20.0	20.0	20.0	20.0	16.5	12.5	10.0	7.5	6.0	4.5	3.0	2.0	1.5	insufficient capacity				
130		20.0	20.0	20.0	20.0	20.0	19.0	14.5	11.5	9.0	7.0	5.5	4.0	3.0	2.0	1.0	insufficient capacity			
	0 props				HPPlus		1 row of props													
(mm)	3000	3200	3400	3600	3800	4000	4200	4400	4600	4800	5000	5200	5400	5600	5800	6000	6200	6400	6600	
140	20.0	19.5	15.5	12.5	10.0	7.5	6.0	4.5	3.5	2.5	1.5	insufficient capacity								
150	20.0	20.0	20.0	16.0	13.0	10.5	8.0	6.5	5.0	4.0	3.0	2.0	1.5	insufficient capacity						
160	20.0	20.0	20.0	19.0	16.5	13.5	11.0	9.0	7.0	6.0	4.5	3.5	2.5	1.5	insufficient capacity					
170	20.0	20.0	20.0	20.0	18.5	17.0	14.0	11.5	9.5	8.0	6.5	5.0	4.0	3.0	2.0	1.0	insufficient capacity			
180	20.0	20.0	20.0	20.0	19.5	17.5	16.5	14.0	12.0	10.0	8.0	6.5	5.5	4.0	3.0	2.0	1.5	insufficient capacity		
190	20.0	20.0	20.0	20.0	20.0	18.5	17.0	16.0	14.5	12.5	10.5	8.5	7.0	6.0	4.5	3.5	2.5	1.5	insufficient capacity	
	1 row of props							2 rows of props												
(mm)	4400	4600	4800	5000	5200	5400	5600	5800	6000	6200	6400	6600	6800	7000	7200	7400	7600	7800	8000	
200	16.5	15.5	14.5	13.0	11.0	9.0	7.5	6.0	5.0	3.5	3.0	2.0	1.0	insufficient capacity						
210	17.5	16.0	15.0	14.0	13.0	11.0	9.5	7.5	6.5	5.0	4.0	3.0	2.0	1.5	insufficient capacity					
220	18.5	17.0	16.0	14.5	13.5	12.5	11.5	9.5	8.0	6.5	5.0	4.0	3.0	2.0	1.5	insufficient capacity				
230	19.0	18.0	16.5	15.5	14.5	13.5	12.5	11.5	10.0	8.5	7.0	5.5	4.5	3.5	2.5	1.5	insufficient capacity			
240	20.0	18.5	17.0	16.0	15.0	14.0	13.0	12.0	11.5	10.0	8.5	7.0	5.5	4.5	3.5	2.5	1.5	insufficient capacity		
250	20.0	19.5	18.0	16.5	15.5	14.5	13.5	12.5	12.0	11.0	10.0	8.5	7.0	6.0	4.5	3.5	2.5	2.0	1.0	
	2 rows of props										3 rows of props									

Table 13c

1.00mm STRAMIT CONDECK HP® COMPOSITE SLAB – using 40MPa concrete CONTINUOUS SPAN – limited by strength or total deflection – MAXIMUM IMPOSED LIVE LOAD (kPa)																				
slab thickness (mm)	span length (mm)																			
	1800	2000	2200	2400	2600	2800	3000	3200	3400	3600	3800	4000	4200	4400	4600	4800	5000	5200	5400	
90	20.0	20.0	16.0	11.5	8.0	5.5	4.0	3.0	2.0	1.0	insufficient capacity									
100	20.0	20.0	20.0	17.5	12.5	9.5	7.0	5.0	3.5	2.5	1.5	insufficient capacity								
110	20.0	20.0	20.0	20.0	18.0	14.0	10.5	7.5	5.5	4.0	3.0	2.0	1.0	insufficient capacity						
120	20.0	20.0	20.0	20.0	20.0	19.0	14.5	11.0	8.5	6.5	5.0	3.5	2.5	1.5	insufficient capacity					
125		20.0	20.0	20.0	20.0	20.0	17.0	13.0	10.0	7.5	6.0	4.5	3.0	2.0	1.5	insufficient capacity				
130		20.0	20.0	20.0	20.0	20.0	19.5	15.0	12.0	9.0	7.0	5.5	4.0	3.0	2.0	1.0	insufficient capacity			
	0 props				HPPlus		1 row of props													
(mm)	3000	3200	3400	3600	3800	4000	4200	4400	4600	4800	5000	5200	5400	5600	5800	6000	6200	6400	6600	
140	20.0	20.0	16.0	12.5	10.0	8.0	6.0	4.5	3.5	2.5	1.5	insufficient capacity								
150	20.0	20.0	20.0	16.5	13.0	10.5	8.5	6.5	5.0	4.0	3.0	2.0	1.0	insufficient capacity						
160	20.0	20.0	20.0	19.5	17.0	13.5	11.0	9.0	7.0	5.5	4.5	3.5	2.5	1.5	insufficient capacity					
170	20.0	20.0	20.0	20.0	19.0	17.5	14.0	11.5	9.5	8.0	6.5	5.0	4.0	3.0	2.0	1.0	insufficient capacity			
180	20.0	20.0	20.0	20.0	20.0	18.5	17.0	14.5	12.0	10.0	8.0	6.5	5.5	4.0	3.0	2.0	1.5	insufficient capacity		
190	20.0	20.0	20.0	20.0	20.0	19.0	17.5	16.5	15.0	12.5	10.5	8.5	7.0	6.0	4.5	3.5	2.5	1.5	insufficient capacity	
	1 row of props							2 rows of props												
(mm)	4400	4600	4800	5000	5200	5400	5600	5800	6000	6200	6400	6600	6800	7000	7200	7400	7600	7800	8000	
200	17.0	16.0	15.0	13.0	11.0	9.0	7.5	6.0	5.0	3.5	3.0	2.0	1.0	insufficient capacity						
210	18.0	16.5	15.5	14.5	13.0	11.0	9.5	7.5	6.5	5.0	4.0	3.0	2.0	1.5	insufficient capacity					
220	19.0	17.5	16.0	15.0	14.0	13.0	11.5	9.5	8.0	6.5	5.0	4.0	3.0	2.0	1.5	insufficient capacity				
230	19.5	18.5	17.0	16.0	14.5	13.5	13.0	11.5	10.0	8.5	7.0	5.5	4.5	3.5	2.5	1.5	insufficient capacity			
240	20.0	19.0	17.5	16.5	15.5	14.5	13.5	12.5	11.5	10.0	8.5	7.0	5.5	4.5	3.5	2.5	1.5	insufficient capacity		
250	20.0	20.0	18.5	17.0	16.0	15.0	14.0	13.0	12.5	11.5	10.0	8.5	7.0	6.0	4.5	3.5	2.5	2.0	1.0	
	2 rows of props										3 rows of props									

Slab thicknesses shaded are not recommended for exposed ceilings. The threshold varies with **Stramit Condeck HP®** Decking thicknesses for 0.75, 100 slab or less is ok, for 0.90, 180 slab or less is ok, and for 1.00, 230 slab or less is ok.

continuous spans



Additional notes to tables:-

The span/depth (L/D) ratio of any slab is assumed to be not less than 15.

Areas indicated as HP Plus allow the option of using 1 row of props or, utilising **Stramit Condeck HP Plus™** End Span Accessory installed as per the conditions within this manual.

All spans shown are effective end spans as defined on page 4.

Refer also to the comprehensive table notes on page 12.

Internal span can be increased by up to 20%.

Table 14a

0.75mm STRAMIT CONDECK HP® COMPOSITE SLAB – using 25MPa concrete																			
CONTINUOUS SPAN – limited by strength or incremental deflection																			
– MAXIMUM IMPOSED LIVE LOAD (kPa)																			
slab thickness (mm)	span length (mm)																		
	1800	2000	2200	2400	2600	2800	3000	3200	3400	3600	3800	4000	4200	4400	4600	4800	5000	5200	5400
90	14.5	10.0	7.0	5.0	3.5	2.5	1.5	insufficient capacity											
100	20.0	14.0	10.0	7.5	5.5	3.5	2.5											1.5	
110	20.0	19.0	14.0	10.5	7.5	5.5	4.0	3.0	2.0	1.0	insufficient capacity								
120	20.0	20.0	18.5	14.0	10.5	8.0	6.0	4.5	3.0	2.0							1.0		
125		20.0	20.0	16.0	12.0	9.0	7.0	5.5	4.0	2.5	2.0	1.0	insufficient capacity						
130		20.0	20.0	18.0	14.0	10.5	8.0	6.0	4.5	3.5	2.5	1.5							
	0 props			HP Plus		1 row of props													
(mm)	3000	3200	3400	3600	3800	4000	4200	4400	4600	4800	5000	5200	5400	5600	5800	6000	6200	6400	6600
140	11.0	8.5	6.5	5.0	4.0	2.5	2.0	1.0	insufficient capacity										
150	14.0	11.0	9.0	7.0	5.5	4.0	3.0	2.0											
160	17.5	14.0	11.5	9.0	7.5	5.5	4.5	3.5	2.5	1.5	insufficient capacity								
170	20.0	17.5	14.0	11.5	9.5	7.5	6.0	4.5	3.5	2.5									
180	20.0	20.0	17.0	14.0	11.5	9.5	7.5	6.0	5.0	3.5	2.5	2.0	1.0	insufficient capacity					
190	20.0	20.0	20.0	17.5	14.5	12.0	10.0	8.0	6.5	5.0	4.0	3.0	2.0						1.5
	1 row of props						2 rows of props												
(mm)	4400	4600	4800	5000	5200	5400	5600	5800	6000	6200	6400	6600	6800	7000	7200	7400	7600	7800	8000
200	10.0	8.0	6.5	5.0	4.0	3.0	2.0	1.5	insufficient capacity										
210	12.0	10.0	8.0	6.5	5.5	4.0	3.0	2.5											
220	14.0	11.5	10.0	8.0	6.5	5.5	4.0	3.0	2.5	1.5	insufficient capacity								
230	16.5	14.0	12.0	10.0	8.5	7.0	5.5	4.5	3.5	2.5									
240	19.0	16.5	14.0	12.0	10.0	8.5	7.0	5.5	4.5	3.5	2.5	2.0	1.0	insufficient capacity					
250	20.0	18.5	16.0	13.5	11.5	10.0	8.0	7.0	5.5	4.5	3.5	2.5	1.5						
	2 rows of props						3 rows of props						4 rows of props						

Slab thicknesses shaded are not recommended for exposed ceilings. The threshold varies with **Stramit Condeck HP®** Decking thicknesses for 0.75, 100 slab or less is ok, for 0.90, 180 slab or less is ok, and for 1.00, 230 slab or less is ok.

Table I4b

0.90mm STRAMIT CONDECK HP® COMPOSITE SLAB – using 25MPa concrete CONTINUOUS SPAN – limited by strength or incremental deflection – MAXIMUM IMPOSED LIVE LOAD (kPa)																				
slab thickness (mm)	span length (mm)																			
	1800	2000	2200	2400	2600	2800	3000	3200	3400	3600	3800	4000	4200	4400	4600	4800	5000	5200	5400	
90	15.5	10.5	7.5	5.0	3.5	2.5	1.5													
100	20.0	15.0	10.5	7.5	5.5	4.0	2.5	1.5												
110	20.0	20.0	14.5	10.5	8.0	6.0	4.0	3.0	2.0	1.0										
120	20.0	20.0	19.0	14.0	11.0	8.0	6.0	4.5	3.0	2.0	1.0									insufficient capacity
125		20.0	20.0	16.0	12.5	9.5	7.0	5.5	4.0	2.5	1.5									
130		20.0	20.0	18.5	14.0	11.0	8.5	6.5	4.5	3.5	2.5	1.5								
	0 props				HPPlus		1 row of props													
(mm)	3000	3200	3400	3600	3800	4000	4200	4400	4600	4800	5000	5200	5400	5600	5800	6000	6200	6400	6600	
140	11.0	8.5	6.5	5.0	3.5	2.5	1.5													
150	14.0	11.0	8.5	7.0	5.0	4.0	3.0	2.0	1.0											
160	18.0	14.0	11.5	9.0	7.0	5.5	4.5	3.0	2.0	1.5										insufficient capacity
170	20.0	17.5	14.0	11.5	9.0	7.5	5.5	4.5	3.5	2.5	1.5									
180	20.0	20.0	17.0	14.0	11.5	9.0	7.5	6.0	4.5	3.5	2.5	1.5								
190	20.0	20.0	20.0	17.0	14.0	11.5	9.5	8.0	6.5	5.0	4.0	3.0	2.0	1.0						
	1 row of props							2 rows of props												
(mm)	4400	4600	4800	5000	5200	5400	5600	5800	6000	6200	6400	6600	6800	7000	7200	7400	7600	7800	8000	
200	9.5	8.0	6.5	5.0	4.0	3.0	2.0	1.5												
210	11.5	9.5	8.0	6.5	5.0	4.0	3.0	2.0	1.5											
220	13.5	11.5	9.5	8.0	6.5	5.0	4.0	3.0	2.0	1.5										insufficient capacity
230	16.5	14.0	11.5	10.0	8.0	6.5	5.5	4.5	3.5	2.5	1.5									
240	19.0	16.0	13.5	11.5	9.5	8.0	6.5	5.5	4.5	3.5	2.5	1.5								
250	20.0	18.5	16.0	13.5	11.5	9.5	8.0	6.5	5.5	4.5	3.5	2.5	1.5							
	2 rows of props										3 rows of props									

Table I4c

1.00mm STRAMIT CONDECK HP® COMPOSITE SLAB – using 25MPa concrete CONTINUOUS SPAN – limited by strength or incremental deflection – MAXIMUM IMPOSED LIVE LOAD (kPa)																				
slab thickness (mm)	span length (mm)																			
	1800	2000	2200	2400	2600	2800	3000	3200	3400	3600	3800	4000	4200	4400	4600	4800	5000	5200	5400	5400
90	16.0	11.0	8.0	5.5	3.5	2.5	1.5													
100	20.0	15.5	11.0	8.0	5.5	4.0	2.5	1.5												
110	20.0	20.0	15.0	11.0	8.0	6.0	4.5	3.0	2.0	1.0										
120	20.0	20.0	19.5	14.5	11.0	8.5	6.0	4.5	3.0	2.0	1.5									insufficient capacity
125		20.0	20.0	16.5	12.5	9.5	7.5	5.5	4.0	3.0	2.0	1.0								
130		20.0	20.0	19.0	14.5	11.0	8.5	6.5	4.5	3.5	2.5	1.5								
	0 props				HPPlus		1 row of props													
(mm)	3000	3200	3400	3600	3800	4000	4200	4400	4600	4800	5000	5200	5400	5600	5800	6000	6200	6400	6600	
140	11.0	8.5	6.5	5.0	3.5	2.5	1.5													
150	14.0	11.0	9.0	7.0	5.0	4.0	3.0	2.0	1.0											
160	18.0	14.5	11.5	9.0	7.0	5.5	4.0	3.0	2.0	1.5										insufficient capacity
170	20.0	17.5	14.0	11.5	9.0	7.5	5.5	4.5	3.5	2.5	1.5									
180	20.0	20.0	17.0	14.0	11.5	9.0	7.5	6.0	4.5	3.5	2.5	1.5								
190	20.0	20.0	20.0	17.0	14.0	11.5	9.5	7.5	6.0	5.0	4.0	3.0	2.0	1.0						
	1 row of props							2 rows of props												
(mm)	4400	4600	4800	5000	5200	5400	5600	5800	6000	6200	6400	6600	6800	7000	7200	7400	7600	7800	8000	
200	9.5	8.0	6.5	5.0	4.0	3.0	2.0	1.0												
210	11.5	9.5	8.0	6.5	5.0	4.0	3.0	2.0	1.5											
220	13.5	11.5	9.5	8.0	6.5	5.0	4.0	3.0	2.0	1.5										insufficient capacity
230	16.5	14.0	11.5	9.5	8.0	6.5	5.5	4.0	3.0	2.5	1.5									
240	19.0	16.0	13.5	11.5	9.5	8.0	6.5	5.5	4.0	3.0	2.5	1.5								
250	20.0	18.5	15.5	13.5	11.5	9.5	8.0	6.5	5.5	4.0	3.0	2.5	1.5							
	2 rows of props										3 rows of props									

Slab thicknesses shaded are not recommended for exposed ceilings. The threshold varies with **Stramit Condeck HP®** Decking thicknesses for 0.75, 100 slab or less is ok, for 0.90, 180 slab or less is ok, and for 1.00, 230 slab or less is ok.

continuous spans



Additional notes to tables:-

The span/depth (L/D) ratio of any slab is assumed to be not less than 15.

Areas indicated as HP Plus allow the option of using 1 row of props or, utilising **Stramit Condeck HP Plus™** End Span Accessory installed as per the conditions within this manual.

All spans shown are effective end spans as defined on page 4.

Refer also to the comprehensive table notes on page 12.

Internal span can be increased by up to 20%.

Table 15a

0.75mm STRAMIT CONDECK HP® COMPOSITE SLAB – using 32MPa concrete																		
CONTINUOUS SPAN – limited by strength or incremental deflection																		
– MAXIMUM IMPOSED LIVE LOAD (kPa)																		
slab thickness (mm)	span length (mm)																	
	1800	2000	2200	2400	2600	2800	3000	3200	3400	3600	3800	4000	4200	4400	4600	4800	5000	5200
90	16.5	12.0	8.5	6.0	4.5	3.0	2.0	0.5	insufficient capacity									
100	20.0	16.5	12.0	9.0	6.5	5.0	3.5	2.5										
110	20.0	20.0	16.5	12.5	9.5	7.0	5.5	4.0	3.0	2.0	1.0	insufficient capacity						
120	20.0	20.0	20.0	16.5	12.5	10.0	7.5	6.0	4.5	3.0	2.0							1.5
125	20.0		20.0	19.0	14.5	11.5	9.0	7.0	5.0	4.0	3.0	2.0	1.0	insufficient capacity				
130	20.0		20.0	20.0	16.5	13.0	10.0	8.0	6.0	5.0	3.5	2.5	1.5					
	0 props			HP Plus		1 row of props										insufficient capacity		
140	13.5	10.5	8.5	6.5	5.0	4.0	3.0	2.0	1.5	insufficient capacity								
150	17.0	13.5	11.0	9.0	7.0	5.5	4.0	3.5	2.5									1.5
160	20.0	17.0	14.0	11.5	9.5	7.5	6.0	5.0	3.5	2.5	2.0	1.0	insufficient capacity					
170	20.0	20.0	17.0	14.0	11.5	9.5	8.0	6.5	5.0	4.0	3.0	2.0						1.5
180	20.0	20.0	20.0	17.0	14.0	12.0	10.0	8.0	6.5	5.0	4.0	3.0	2.5	1.5	insufficient capacity			
190	20.0	20.0	20.0	20.0	17.5	14.5	12.0	10.0	8.5	7.0	5.5	4.5	3.5	2.5				2.0
	1 row of props					2 rows of props										insufficient capacity		
200	12.0	10.0	8.5	7.0	6.0	4.5	3.5	2.5	2.0	1.0	insufficient capacity							
210	14.5	12.5	10.5	8.5	7.0	6.0	4.5	3.5	3.0	2.0								1.5
220	17.0	14.5	12.0	10.5	8.5	7.0	6.0	5.0	4.0	3.0	2.0	1.5	insufficient capacity					
230	18.5	17.0	14.5	12.5	10.5	9.0	7.5	6.5	5.0	4.0	3.0	2.5						1.5
240	19.0	17.5	16.5	14.5	12.5	10.5	9.0	7.5	6.5	5.0	4.0	3.0	2.5	1.5	insufficient capacity			
250	20.0	18.5	17.0	16.0	14.5	12.5	10.5	9.0	7.5	6.5	5.0	4.0	3.0	2.5				1.5
	2 rows of props				3 rows of props						4 rows of props				insufficient capacity			
200	12.0	10.0	8.5	7.0	6.0	4.5	3.5	2.5	2.0	1.0	insufficient capacity							
210	14.5	12.5	10.5	8.5	7.0	6.0	4.5	3.5	3.0	2.0								1.5
220	17.0	14.5	12.0	10.5	8.5	7.0	6.0	5.0	4.0	3.0	2.0	1.5	insufficient capacity					
230	18.5	17.0	14.5	12.5	10.5	9.0	7.5	6.5	5.0	4.0	3.0	2.5						1.5
240	19.0	17.5	16.5	14.5	12.5	10.5	9.0	7.5	6.5	5.0	4.0	3.0	2.5	1.5	insufficient capacity			
250	20.0	18.5	17.0	16.0	14.5	12.5	10.5	9.0	7.5	6.5	5.0	4.0	3.0	2.5				1.5
	2 rows of props				3 rows of props						4 rows of props				insufficient capacity			

Slab thicknesses shaded are not recommended for exposed ceilings. The threshold varies with **Stramit Condeck HP®** Decking thicknesses for 0.75, 100 slab or less is ok, for 0.90, 180 slab or less is ok, and for 1.00, 230 slab or less is ok.

Table 15b

0.90mm STRAMIT CONDECK HP® COMPOSITE SLAB – using 32MPa concrete CONTINUOUS SPAN – limited by strength or incremental deflection – MAXIMUM IMPOSED LIVE LOAD (kPa)																					
slab thickness (mm)	span length (mm)																				
	1800	2000	2200	2400	2600	2800	3000	3200	3400	3600	3800	4000	4200	4400	4600	4800	5000	5200	5400		
90	17.5	12.5	9.0	6.5	4.5	3.0	2.0	1.0													
100	20.0	17.0	12.5	9.0	6.5	5.0	3.5	2.5	1.5												
110	20.0	20.0	16.5	12.5	9.5	7.0	5.5	4.0	2.5	2.0	1.0										
120	20.0	20.0	20.0	16.5	13.0	10.0	7.5	5.5	4.5	3.0	2.0	1.5								insufficient capacity	
125		20.0	20.0	19.0	14.5	11.5	9.0	7.0	5.0	4.0	3.0	2.0	1.0								
130		20.0	20.0	20.0	17.0	13.0	10.0	8.0	6.0	4.5	3.5	2.5	1.5								
	0 props				HPPlus		1 row of props														

(mm)	3000	3200	3400	3600	3800	4000	4200	4400	4600	4800	5000	5200	5400	5600	5800	6000	6200	6400	6600	
140	13.5	10.5	8.5	6.5	5.0	4.0	3.0	2.0	1.0											insufficient capacity
150	17.0	13.5	11.0	8.5	7.0	5.5	4.0	3.0	2.0	1.5										
160	20.0	17.0	14.0	11.5	9.0	7.5	6.0	4.5	3.5	2.5	2.0	1.0								
170	20.0	20.0	17.0	14.0	11.5	9.5	7.5	6.0	5.0	4.0	3.0	2.0	1.0							
180	20.0	20.0	20.0	17.0	14.0	11.5	9.5	7.5	6.5	5.0	4.0	3.0	2.0	1.5						
190	20.0	20.0	20.0	20.0	17.0	14.5	12.0	10.0	8.0	6.5	5.5	4.5	3.5	2.5	1.5					
	1 row of props							2 rows of props												

(mm)	4400	4600	4800	5000	5200	5400	5600	5800	6000	6200	6400	6600	6800	7000	7200	7400	7600	7800	8000	
200	12.0	10.0	8.5	7.0	5.5	4.5	3.5	2.5	2.0	1.0										insufficient capacity
210	14.5	12.0	10.0	8.5	7.0	5.5	4.5	3.5	2.5	2.0	1.0									
220	17.0	14.5	12.0	10.0	8.5	7.0	6.0	4.5	3.5	3.0	2.0	1.0								
230	19.0	17.0	14.5	12.5	10.5	9.0	7.5	6.0	5.0	4.0	3.0	2.0	1.5							
240	20.0	18.5	16.5	14.5	12.0	10.5	9.0	7.5	6.0	5.0	4.0	3.0	2.0	1.5						
250	20.0	19.5	18.0	16.5	14.0	12.0	10.5	9.0	7.5	6.0	5.0	4.0	3.0	2.0	1.5					
	2 rows of props							3 rows of props												

Table 15c

1.00mm STRAMIT CONDECK HP® COMPOSITE SLAB – using 32MPa concrete CONTINUOUS SPAN – limited by strength or incremental deflection – MAXIMUM IMPOSED LIVE LOAD (kPa)																					
slab thickness (mm)	span length (mm)																				
	1800	2000	2200	2400	2600	2800	3000	3200	3400	3600	3800	4000	4200	4400	4600	4800	5000	5200	5400		
90	18.0	12.5	9.0	6.5	4.5	3.0	2.0	1.0													
100	20.0	17.5	12.5	9.0	6.5	5.0	3.5	2.5	1.5												
110	20.0	20.0	17.0	12.5	9.5	7.0	5.5	4.0	2.5	2.0	1.0										
120	20.0	20.0	20.0	17.0	13.0	10.0	7.5	6.0	4.5	3.0	2.0	1.5								insufficient capacity	
125		20.0	20.0	19.5	15.0	11.5	9.0	7.0	5.0	4.0	2.5	2.0	1.0								
130		20.0	20.0	20.0	17.0	13.0	10.0	8.0	6.0	4.5	3.5	2.5	1.5								
	0 props				HPPlus		1 row of props														

(mm)	3000	3200	3400	3600	3800	4000	4200	4400	4600	4800	5000	5200	5400	5600	5800	6000	6200	6400	6600	
140	13.5	10.5	8.5	6.5	5.0	4.0	3.0	2.0	1.0											insufficient capacity
150	17.0	13.5	11.0	8.5	7.0	5.5	4.0	3.0	2.0	1.5										
160	20.0	17.0	14.0	11.0	9.0	7.5	6.0	4.5	3.5	2.5	1.5									
170	20.0	20.0	17.0	14.0	11.5	9.5	7.5	6.0	4.5	3.5	2.5	2.0	1.0							
180	20.0	20.0	20.0	17.0	14.0	11.5	9.5	7.5	6.0	5.0	4.0	3.0	2.0	1.5						
190	20.0	20.0	20.0	20.0	17.0	14.0	12.0	10.0	8.0	6.5	5.5	4.0	3.0	2.5	1.5					
	1 row of props							2 rows of props												

(mm)	4400	4600	4800	5000	5200	5400	5600	5800	6000	6200	6400	6600	6800	7000	7200	7400	7600	7800	8000	
200	12.0	10.0	8.5	7.0	5.5	4.5	3.5	2.5	1.5											insufficient capacity
210	14.0	12.0	10.0	8.5	7.0	5.5	4.5	3.5	2.5	2.0	1.0									
220	16.5	14.0	12.0	10.0	8.5	7.0	5.5	4.5	3.5	2.5	2.0	1.0								
230	19.5	17.0	14.5	12.0	10.5	8.5	7.0	6.0	5.0	4.0	3.0	2.0	1.5							
240	20.0	19.0	16.5	14.0	12.0	10.5	8.5	7.5	6.0	5.0	4.0	3.0	2.0	1.5						
250	20.0	20.0	18.5	16.5	14.0	12.0	10.5	8.5	7.5	6.0	5.0	4.0	3.0	2.0	1.5					
	2 rows of props							3 rows of props												

Slab thicknesses shaded are not recommended for exposed ceilings. The threshold varies with **Stramit Condeck HP®** Decking thicknesses for 0.75, 100 slab or less is ok, for 0.90, 180 slab or less is ok, and for 1.00, 230 slab or less is ok.

continuous spans

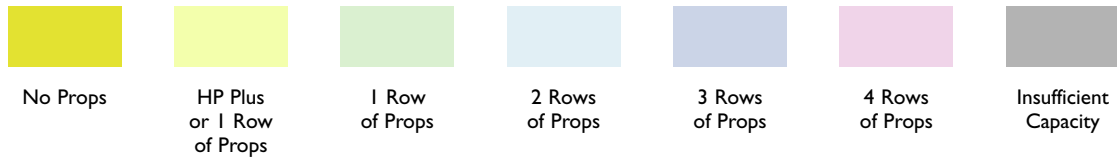

Additional notes to tables:-

The span/depth (L/D) ratio of any slab is assumed to be not less than 15.

Areas indicated as HP Plus allow the option of using 1 row of props or, utilising **Stramit Condeck HP Plus™** End Span Accessory installed as per the conditions within this manual.

All spans shown are effective end spans as defined on page 4.

Refer also to the comprehensive table notes on page 12.

Internal span can be increased by up to 20%.

Table 16a

0.75mm STRAMIT CONDECK HP® COMPOSITE SLAB – using 40MPa concrete																			
CONTINUOUS SPAN – limited by strength or incremental deflection																			
– MAXIMUM IMPOSED LIVE LOAD (kPa)																			
slab thickness (mm)	span length (mm)																		
	1800	2000	2200	2400	2600	2800	3000	3200	3400	3600	3800	4000	4200	4400	4600	4800	5000	5200	5400
90	18.5	13.5	10.0	7.0	5.5	4.0	2.5	1.0	insufficient capacity										
100	20.0	19.0	14.0	11.0	8.0	6.0	4.5	3.5											2.5
110	20.0	20.0	19.5	15.0	11.5	9.0	7.0	5.0	4.0	3.0	2.0	1.0	insufficient capacity						
120	20.0	20.0	20.0	19.5	15.5	12.0	9.5	7.5	5.5	4.5	3.0	2.5							1.5
125		20.0	20.0	20.0	17.5	14.0	11.0	8.5	7.0	5.0	4.0	3.0	2.0	1.0	insufficient capacity				
130		20.0	20.0	20.0	20.0	15.5	12.5	10.0	8.0	6.0	5.0	3.5	2.5	2.0					
	0 props			HP Plus		1 row of props											2 rows of props		1.0 2 rows of props
(mm)	3000	3200	3400	3600	3800	4000	4200	4400	4600	4800	5000	5200	5400	5600	5800	6000	6200	6400	6600
140	16.0	13.0	10.5	8.5	7.0	5.5	4.0	3.0	2.5	1.5	insufficient capacity								
150	20.0	16.5	13.5	11.0	9.0	7.0	5.5	4.5	3.5	2.5									
160	20.0	20.0	17.0	14.0	11.5	9.5	7.5	6.5	5.0	4.0	3.0	2.0	1.5	insufficient capacity					
170	20.0	20.0	20.0	17.0	14.0	11.5	10.0	8.0	6.5	5.5	4.0	3.5	2.5						1.5
180	20.0	20.0	20.0	20.0	17.0	14.5	12.0	10.0	8.5	7.0	5.5	4.5	3.5	2.5	2.0	1.0	insufficient capacity		
190	20.0	20.0	20.0	20.0	19.5	17.5	15.0	12.5	10.5	9.0	7.5	6.0	5.0	4.0	3.0	2.0			
	1 row of props					2 rows of props										3 rows of props			
(mm)	4400	4600	4800	5000	5200	5400	5600	5800	6000	6200	6400	6600	6800	7000	7200	7400	7600	7800	8000
200	15.0	12.5	10.5	9.0	7.5	6.0	5.0	4.0	3.0	2.5	1.5	insufficient capacity							
210	16.5	15.0	12.5	11.0	9.0	7.5	6.5	5.5	4.0	3.5	2.5								
220	17.5	16.0	15.0	13.0	11.0	9.5	8.0	6.5	5.5	4.5	3.5	2.5	2.0	1.0	insufficient capacity				
230	18.5	17.0	16.0	14.5	13.0	11.0	9.5	8.0	7.0	5.5	4.5	3.5	3.0	2.0					1.5
240	19.0	18.0	16.5	15.5	14.5	13.0	11.5	9.5	8.0	7.0	6.0	5.0	4.0	3.0	2.0	1.5	insufficient capacity		
250	20.0	18.5	17.5	16.0	15.0	14.0	13.0	11.5	9.5	8.5	7.0	6.0	5.0	4.0	3.0	2.0			
	2 rows of props				3 rows of props								4 rows of props						

Slab thicknesses shaded are not recommended for exposed ceilings. The threshold varies with **Stramit Condeck HP®** Decking thicknesses for 0.75, 100 slab or less is ok, for 0.90, 180 slab or less is ok, and for 1.00, 230 slab or less is ok.

Table I6b

0.90mm STRAMIT CONDECK HP® COMPOSITE SLAB – using 40MPa concrete CONTINUOUS SPAN – limited by strength or incremental deflection – MAXIMUM IMPOSED LIVE LOAD (kPa)																				
slab thickness (mm)	span length (mm)																			
	1800	2000	2200	2400	2600	2800	3000	3200	3400	3600	3800	4000	4200	4400	4600	4800	5000	5200	5400	
90	19.5	14.0	10.0	7.5	5.5	4.0	2.5	1.5	insufficient capacity											
100	20.0	19.5	14.5	10.5	8.0	6.0	4.5	3.5	2.0	1.5	insufficient capacity									
110	20.0	20.0	19.5	15.0	11.5	9.0	6.5	5.0	4.0	2.5	2.0	1.0	insufficient capacity							
120	20.0	20.0	20.0	19.5	15.5	12.0	9.5	7.5	5.5	4.5	3.0	2.0	1.5	insufficient capacity						
125		20.0	20.0	20.0	17.5	13.5	11.0	8.5	6.5	5.0	4.0	3.0	2.0	1.0	insufficient capacity					
130		20.0	20.0	20.0	20.0	15.5	12.5	10.0	8.0	6.0	4.5	3.5	2.5	1.5	insufficient capacity					
	0 props				HPPlus		1 row of props													
(mm)	3000	3200	3400	3600	3800	4000	4200	4400	4600	4800	5000	5200	5400	5600	5800	6000	6200	6400	6600	
140	16.0	13.0	10.5	8.5	6.5	5.0	4.0	3.0	2.0	1.5	insufficient capacity									
150	20.0	16.5	13.0	11.0	9.0	7.0	5.5	4.5	3.5	2.5	1.5	insufficient capacity								
160	20.0	20.0	16.5	13.5	11.5	9.0	7.5	6.0	4.5	4.0	3.0	2.0	1.5	insufficient capacity						
170	20.0	20.0	20.0	17.0	14.0	11.5	9.5	8.0	6.5	5.0	4.0	3.0	2.5	1.5	insufficient capacity					
180	20.0	20.0	20.0	20.0	17.0	14.0	11.5	9.5	8.0	6.5	5.5	4.5	3.5	2.5	2.0	1.0	insufficient capacity			
190	20.0	20.0	20.0	20.0	20.0	17.0	14.5	12.5	10.5	8.5	7.0	6.0	4.5	3.5	3.0	2.0	1.5	insufficient capacity		
	1 row of props							2 rows of props												
(mm)	4400	4600	4800	5000	5200	5400	5600	5800	6000	6200	6400	6600	6800	7000	7200	7400	7600	7800	8000	
200	14.5	12.5	10.5	9.0	7.5	6.0	5.0	4.0	3.0	2.0	1.5	insufficient capacity								
210	17.5	14.5	12.5	10.5	9.0	7.5	6.0	5.0	4.0	3.0	2.5	1.5	insufficient capacity							
220	18.5	17.0	14.5	12.5	10.5	9.0	7.5	6.5	5.0	4.0	3.5	2.5	1.5	insufficient capacity						
230	19.0	18.0	16.5	15.0	13.0	11.0	9.5	8.0	6.5	5.5	4.5	3.5	2.5	2.0	1.5	insufficient capacity				
240	20.0	18.5	17.0	16.0	15.0	13.0	11.0	9.5	8.0	7.0	5.5	4.5	3.5	3.0	2.0	1.5	insufficient capacity			
250	20.0	19.5	18.0	16.5	15.5	14.5	13.0	11.0	9.5	8.0	7.0	5.5	4.5	3.5	3.0	2.0	1.5	insufficient capacity		
	2 rows of props							3 rows of props												

Table I6c

1.00mm STRAMIT CONDECK HP® COMPOSITE SLAB – using 40MPa concrete CONTINUOUS SPAN – limited by strength or incremental deflection – MAXIMUM IMPOSED LIVE LOAD (kPa)																				
slab thickness (mm)	span length (mm)																			
	1800	2000	2200	2400	2600	2800	3000	3200	3400	3600	3800	4000	4200	4400	4600	4800	5000	5200	5400	
90	20.0	14.0	10.5	7.5	5.5	4.0	2.5	1.5	insufficient capacity											
100	20.0	20.0	14.5	11.0	8.0	6.0	4.5	3.0	2.0	1.5	insufficient capacity									
110	20.0	20.0	20.0	15.0	11.5	9.0	6.5	5.0	4.0	2.5	2.0	1.0	insufficient capacity							
120	20.0	20.0	20.0	20.0	15.0	12.0	9.5	7.5	5.5	4.0	3.0	2.0	1.5	insufficient capacity						
125		20.0	20.0	20.0	17.5	13.5	11.0	8.5	6.5	5.0	4.0	3.0	2.0	1.0	insufficient capacity					
130		20.0	20.0	20.0	20.0	15.5	12.5	10.0	7.5	6.0	4.5	3.5	2.5	1.5	insufficient capacity					
	0 props				HPPlus		1 row of props													
(mm)	3000	3200	3400	3600	3800	4000	4200	4400	4600	4800	5000	5200	5400	5600	5800	6000	6200	6400	6600	
140	16.0	13.0	10.5	8.5	6.5	5.0	4.0	3.0	2.0	1.5	insufficient capacity									
150	20.0	16.5	13.0	10.5	8.5	7.0	5.5	4.5	3.0	2.5	1.5	insufficient capacity								
160	20.0	20.0	16.5	13.5	11.0	9.0	7.5	6.0	4.5	3.5	3.0	2.0	1.5	insufficient capacity						
170	20.0	20.0	20.0	16.5	14.0	11.5	9.5	7.5	6.0	5.0	4.0	3.0	2.5	1.5	insufficient capacity					
180	20.0	20.0	20.0	20.0	17.0	14.0	11.5	9.5	8.0	6.5	5.5	4.5	3.5	2.5	1.5	insufficient capacity				
190	20.0	20.0	20.0	20.0	20.0	17.0	14.5	12.0	10.0	8.5	7.0	6.0	4.5	3.5	3.0	2.0	1.5	insufficient capacity		
	1 row of props							2 rows of props												
(mm)	4400	4600	4800	5000	5200	5400	5600	5800	6000	6200	6400	6600	6800	7000	7200	7400	7600	7800	8000	
200	14.5	12.5	10.5	8.5	7.5	6.0	5.0	4.0	3.0	2.0	1.5	insufficient capacity								
210	17.0	14.5	12.5	10.5	9.0	7.5	6.0	5.0	4.0	3.0	2.5	1.5	insufficient capacity							
220	19.0	17.0	14.5	12.5	10.5	9.0	7.5	6.5	5.0	4.0	3.0	2.5	1.5	insufficient capacity						
230	19.5	18.5	17.0	15.0	13.0	11.0	9.5	8.0	6.5	5.5	4.5	3.5	2.5	2.0	1.0	insufficient capacity				
240	20.0	19.0	17.5	16.5	15.0	13.0	11.0	9.5	8.0	6.5	5.5	4.5	3.5	2.5	2.0	1.5	insufficient capacity			
250	20.0	20.0	18.5	17.0	16.0	15.0	12.5	11.0	9.5	8.0	6.5	5.5	4.5	3.5	3.0	2.0	1.5	insufficient capacity		
	2 rows of props							3 rows of props												

Slab thicknesses shaded are not recommended for exposed ceilings. The threshold varies with **Stramit Condeck HP®** Decking thicknesses for 0.75, 100 slab or less is ok, for 0.90, 180 slab or less is ok, and for 1.00, 230 slab or less is ok.

Loading

Finished slab loading requirements should be established using AS3600 and AS1170.1.

Design Principles

Composite design in this **Stramit Condeck HP®** Composite Slab Technical Manual is based on Partial Shear Connection Theory for positive moment capacity. This has become recognised in Australia as the most accurate method of designing composite slabs. The method relies upon test derived values of coefficient of friction (μ) and mechanical resistance (H_r) to determine the composite strength of particular metal decks. Composite decking slabs are designed as one-way slabs.

Other Cases

The composite tables provided in this manual give only a limited number of the infinite range of span cases and combinations. Stramit has software, **Stramit Condeck HP Slab Designer™** available to compute almost all practical span, slab and loading cases. Talk to your regional Stramit Technical Services Manager if you have a design case beyond the scope of the tables.

Shrinkage & Temperature Mesh

For minor degree of control over cracking for exposure conditions A1 as per AS3600.

Table 17

STRAMIT CONDECK HP® SLABS – Shrinkage & Temperature Reinforcement		
Slab Depth (mm)	Based on Area Above Ribs	Based on Total Concrete Area
90	F62 / SL62	F72 / SL72
100	F62 / SL62	F72 / SL72
110	F62 / SL62	F72 / SL82
120	F62 / SL62	F82 / SL82
125	F62 / SL62	F82 / SL82
130	F62 / SL62	F82 / SL92
140	F62 / SL72	F82 / SL92
150	F72 / SL72	F92 / SL92
160	F72 / SL82	F92 / SL92
170	F82 / SL82	F92 / SL102
180	F82 / SL82	F92 / SL102
190	F82 / SL92	F102 / SL102
200	F92 / SL92	F102 / SL102
210	F92 / SL92	F102 / RL818*
220	F92 / SL92	F102 / RL818*
230	F92 / SL102	F818 / RL818*
240	F102 / SL102	F818 / RL818*
250	F102 / SL102	F818 / RL818*

Traditionally, shrinkage and temperature reinforcement sizes have been calculated based on the area of concrete above the decking ribs. Figures based on the entire slab depth have been included for information only.

This table gives the minimum mesh size required. It may be necessary to increase the size of lighter meshes to prevent damage during construction.

* Main bars should be transverse to the decking ribs.

Negative Reinforcement

The negative reinforcement required for continuous slabs should be established by conventional design methods.

It should be placed with a minimum 20mm cover to the top surface of the slab. If the shrinkage and temperature mesh is placed towards the top of the slab, this may be taken as contributing towards the negative reinforcement required, provided fire design is not required and the mesh has adequate rotation capacity to cater for any moment redistribution assumed.

Crack Control for Flexure

Consideration must be given to control of cracking due to flexure in the tensile regions of the slabs. The bar diameter and spacing must be chosen to comply with the crack control requirements of AS3600. Limits on the minimum area of reinforcement, maximum steel stress and centre to centre spacing of bars are given in Clause 9.4.1 of that Standard.

Type 4 Shear Reinforcement

Composite edge beams must be designed to resist type 4 longitudinal shear. Shear surface types 1 to 3 are readily dealt with using reinforcing and shear studs. However, type 4 shear surfaces may exist in which a complex shear plane passes across the rib tops, over the shear studs and extends from the edge of the slab into the adjacent slab.

Design information is provided in the OneSteel – Composite Structures Design Manual.

To prevent type 4 shear failures, a component may be required to transfer longitudinal shear. A special type 4 shear component (as per the illustration below) is available for **Stramit Condeck HP®** Decking. Please contact your local Stramit office for details.

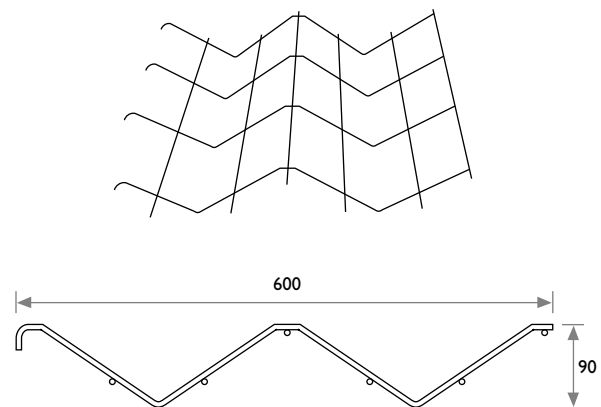

Fire Design

Design Principles

Satisfactory fire design requires confirmation of three criteria, integrity, insulation and structural adequacy.

STRUCTURAL ADEQUACY (resistance to collapse) is generally achieved through the inclusion of Fire Emergency Reinforcement (FER) mesh within the slab. The largely embedded ribs of **Stramit Condeck HP**® Decking allow substantial savings in the amount of FER required. The extent of this reduction is given in table 21. Application of a fire resistant spray coating, or fire-rated ceiling, may also reduce the FER requirement.

INTEGRITY (resistance to the passage of flame or smoke) of a slab is considered to be provided automatically by permanent, overlapping decking such as **Stramit Condeck HP**® Decking, although design care may be needed at ends and edges of the decking.

INSULATION (resistance to excessive slab surface temperature) is normally achieved through selection of a slab of suitable thickness for the required Fire Resistance Period (FRP). For **Stramit Condeck HP**® Decking relevant thicknesses are given in the table below. Alternatively, a fire resistant spray coating can be applied to the underside of the decking, or a fire-rated ceiling system installed.

Slab Insulation Table

Values in this table are based on independent full-scale and pilot tests.

Table 18

STRAMIT CONDECK HP® DECKING – Slab Insulation Performance	
FRP (minutes)	Minimum slab thickness (mm)
60	90
90	100
120	120
180	140
240	170

Based on denseweight concrete.
Data based on combination of full-scale and pilot tests, and independent opinion.

Fire Design

The load-bearing capacity of a section at fire limit state is predicted by engineering calculations based on AS3600 Clause 5.3.1(b). The capacity of the structure is based on the elementary theory of plasticity.

The design method outlined in this brochure can be used to design **Stramit Condeck HP**® Composite Slabs when the soffit is exposed to fire. Certain conditions have been placed in the design formulations. In addition, the following conditions must also be met:

1. The composite slab has been initially designed for room temperature conditions according to this **Stramit Condeck HP**® Composite Slab System Technical Manual.
2. Transverse reinforcement for the control of cracking due to shrinkage and temperature effects must be provided.
3. The fire design load is to be essentially uniformly distributed and static in nature.
4. The composite slab must act as a one-way slab for both room temperature and fire conditions.

Detailing Precautions

It should be noted that on some occasions, fully plastic deformation may not be automatically assured. Low ductility mesh or bars are unlikely to have sufficient rotation capacity to allow for the redistributed moments. Furthermore, the section reinforcement must be long enough to accommodate the complete redistributed moment and change in the location of the inflection points.

Fire Design Procedure

This design procedure utilises the design aids contained in this manual and has been compiled to assist in fire rated **Stramit Condeck HP**® slab design.

1. Design the slab, for a room temperature design, with **Stramit Condeck HP**® Decking using normal design principles and the aids given in this manual. Using conventional techniques, determine the slab specification and the steel reinforcement required.
2. Using Table 18, check the minimum overall slab depth to suit the required Fire Resistance Period.
3. Calculate the slab load w_f .
Where $w_f = 1.1 \times \text{Dead load} + \Psi_c \times \text{Live load}$.
4. Using Tables 19, for the slab thickness and FRP required, check the MAXIMUM effective steel area (A_{st}^*) and lever arm (d_a) for the negative moment cross section of the slab.
5. Select the lower value of negative steel cross sectional area (A_{st}) from steps 1 and 4. It may be possible to improve slab performance by increasing the negative steel up to the value given in step 4.
6. Using the negative steel selected, find the negative moment capacity of the slab at supports and at any critical cross sections.

Negative moment capacity (M_{neg}) = $0.8 \times f_{sy} \times A_{st} \times d_a \times 10^{-6}$.

7. Assume the negative moments due to w_f are equal to the capacity of the slab at one or more points.
8. Assuming equilibrium conditions, calculate the maximum positive moment due to the slab fire load w_f .

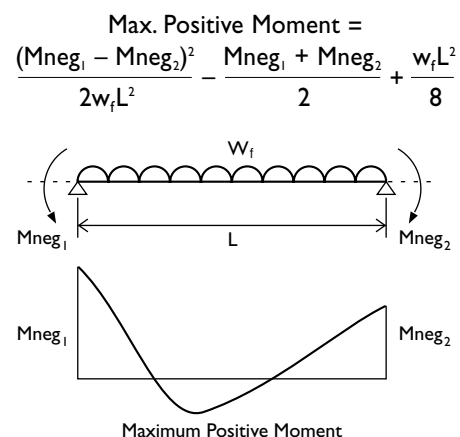

NOTE: M_{neg_1} = Negative moment capacity at support 1
 M_{neg_2} = Negative moment capacity at support 2

9. From Tables 20, determine the amount of positive reinforcement to satisfy the fire slab requirements. Check both internal and end spans of the system.
10. If reinforcement is curtailed, the strength at this cross section must be checked.

Negative Reinforcement For Fire

The following graphs give the MAXIMUM (not the minimum) steel area that can be used in design for various slab depths and FRP levels.

Table 19a

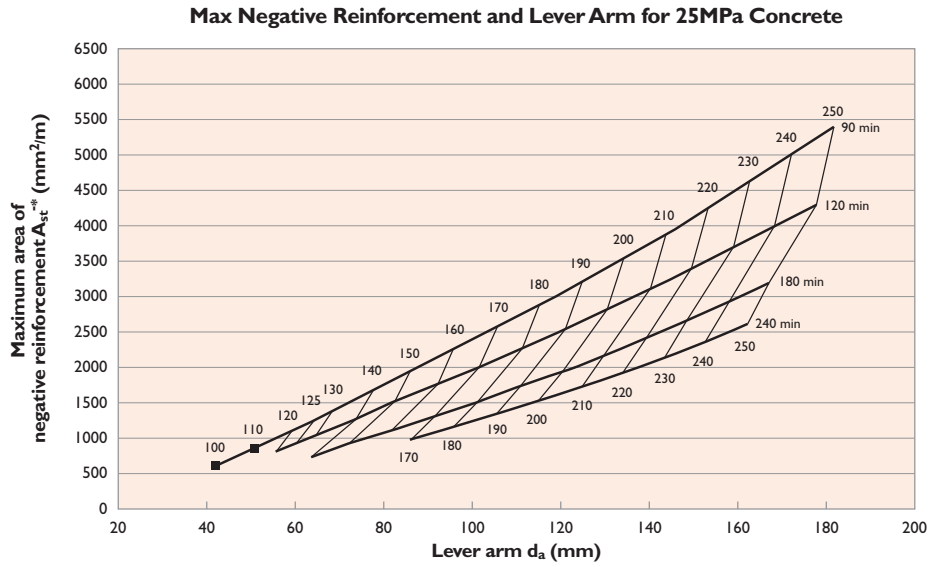

Table 19b

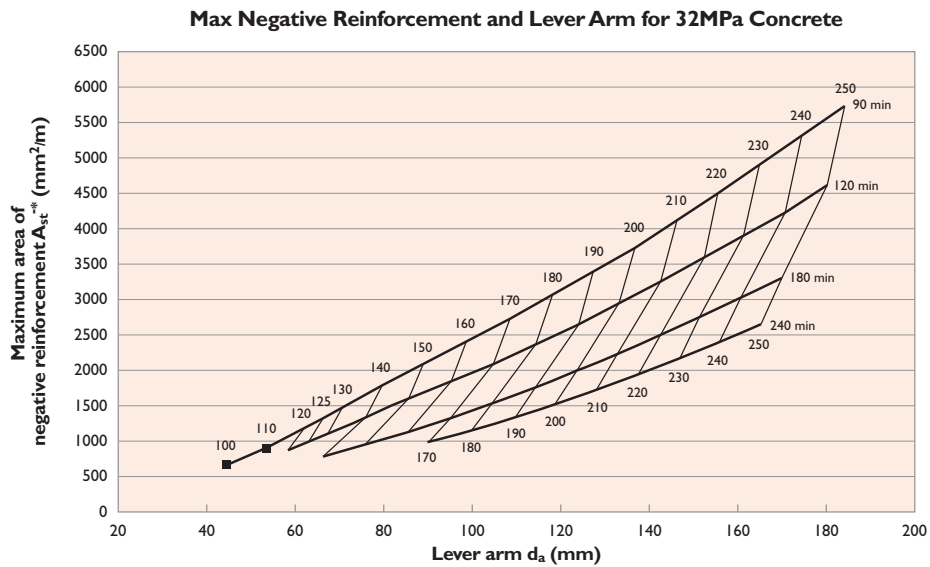
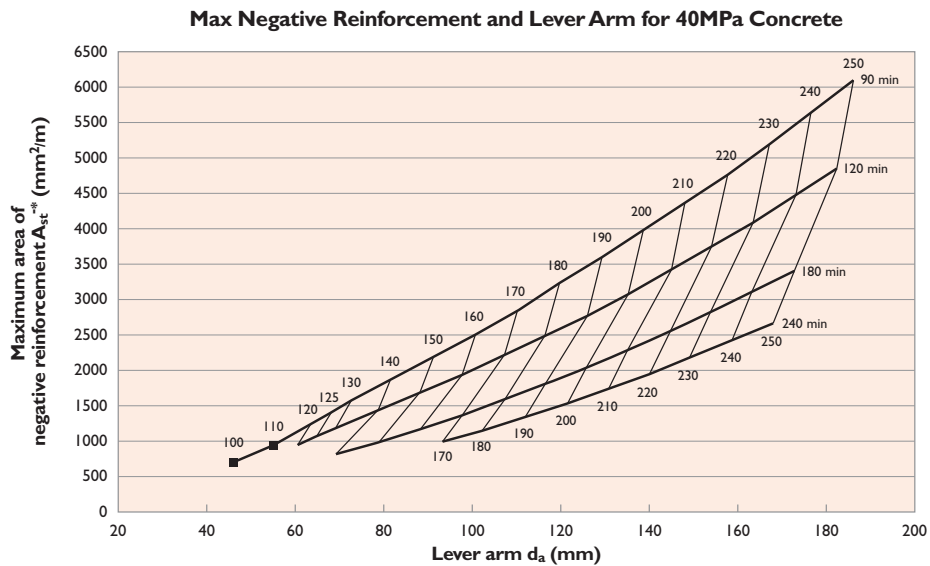

Table 19c



Positive Reinforcement For Fire

Table 20a

STRAMIT CONDECK HP® DECKING – Positive FER Minimum Cross Sectional Area Required (mm²) Fire resistance period – 90 minutes																		
+ve	Slab Depth (mm)																	
Moment ⁺	100	110	120	125	130	140	150	160	170	180	190	200	210	220	230	240	250	
0	0	0	0	0	0	0	0	0	0	0	0	0	0	0	0	0	0	
2	111	91	78	72	67	60	53	48	44	41	38	35	33	31	29	28	26	
4	229	186	157	146	136	120	108	97	89	82	76	71	66	62	59	56	53	
6	355	285	239	222	206	182	162	147	134	123	114	106	100	94	88	84	79	
8	491	389	324	299	278	244	218	197	180	165	153	142	133	125	118	112	106	
10	638	497	411	379	352	308	274	248	226	207	192	178	167	157	148	140	133	
12		612	501	461	427	373	332	299	272	250	231	215	201	188	178	168	159	
14		733	595	545	504	439	390	350	319	292	270	251	235	220	208	196	186	
16		864	692	633	583	506	448	403	366	335	310	288	269	252	238	225	213	
18			794	723	665	575	508	456	414	379	350	325	303	284	268	253	240	
20			901	817	749	645	569	509	462	423	390	362	338	317	298	282	267	
22			1013	914	836	717	630	564	510	467	430	399	373	349	329	311	294	
24				1016	925	790	693	619	560	511	471	437	407	382	359	339	322	
26					1018	866	757	675	609	556	512	475	443	415	390	368	349	
28						1115	943	822	731	660	602	553	513	478	447	421	397	376
30							1022	888	788	710	647	595	551	513	481	452	426	404
32							1103	956	847	762	693	637	590	549	514	483	456	431
34							1187	1024	906	814	740	679	628	585	547	514	485	459
36							1273	1095	966	866	787	722	667	621	581	546	515	487
38								1167	1026	920	835	765	707	657	614	577	544	515
40								1240	1088	973	883	808	746	694	648	609	574	543
42								1316	1151	1028	931	852	786	730	682	640	604	571
44								1393	1215	1083	980	896	826	767	717	672	634	599
46								1472	1281	1139	1029	940	867	804	751	704	664	627
48									1347	1196	1079	985	907	842	786	737	694	656
50									1415	1254	1130	1030	948	879	820	769	724	684
52									1484	1312	1181	1076	990	917	855	802	755	713
54									1555	1372	1233	1122	1031	955	890	834	785	742
56										1432	1285	1169	1073	994	926	867	816	770
58										1494	1338	1215	1116	1032	961	900	846	799
60										1556	1392	1263	1158	1071	997	933	877	828

Table 20c

STRAMIT CONDECK HP® DECKING – Positive FER Minimum Cross Sectional Area Required (mm²) Fire resistance period – 180 minutes															
+ve	Slab Depth (mm)														
Moment ⁺	140	150	160	170	180	190	200	210	220	230	240	250			
0	0	0	0	0	0	0	0	0	0	0	0	0			
2	143	128	116	106	98	91	85	79	75	70	67	63			
4	289	258	234	214	197	182	170	159	149	141	133	127			
6	436	390	353	322	296	274	255	239	225	212	200	190			
8	587	523	473	431	396	367	342	319	300	283	268	254			
10	739	659	594	541	497	460	428	400	376	354	335	318			
12	895	796	717	653	599	554	515	482	452	426	403	382			
14	1054	935	841	765	702	648	603	563	529	498	471	447			
16	1215	1076	967	878	805	743	691	645	606	570	539	511			
18	1380	1219	1094	993	909	839	779	728	683	643	608	576			
20	1549	1365	1223	1108	1014	936	869	811	760	716	676	641			
22	1721	1513	1353	1225	1120	1033	958	894	838	789	745	706			
24	1897	1663	1485	1343	1227	1131	1048	978	916	862	814	772			
26	2077	1817	1619	1462	1335	1229	1139	1062	995	936	884	837			
28	2262	1973	1754	1583	1444	1328	1231	1147	1074	1010	954	903			
30	2452	2131	1892	1705	1554	1428	1323	1232	1153	1084	1024	969			
32	2648	2293	2032	1828	1664	1529	1415	1318	1233	1159	1094	1036			
34	2849	2459	2173	1953	1776	1631	1508	1404	1313	1234	1164	1102			
36	3056	2627	2317	2079	1889	1733	1602	1490	1394	1309	1235	1169			
38		2800	2464	2207	2003	1836	1696	1577	1475	1385	1306	1236			
40		2976	2612	2336	2118	1940	1791	1665	1556	1461	1377	1303			
42		3157	2763	2467	2234	2045	1887	1753	1638	1537	1449	1370			
44		3343	2917	2600	2352	2150	1983	1842	1720	1614	1521	1438			
46		3533	3074	2735	2470	2257	2080	1931	1802	1691	1593	1506			
48			3233	2871	2590	2365	2178	2020	1885	1768	1665	1574			
50			3396	3010	2712	2473	2276	2111	1969	1846	1738	1642			
52			3562	3150	2834	2582	2375	2201	2053	1924	1811	1711			
54				3732	3292	2959	2693	2475	2293	2137	2002	1884	1780		
56					3437	3084	2804	2576	2385	2222	2081	1958	1849		
58					3584	3211	2917	2677	2477	2307	2160	2031	1918		
60					3734	3340	3031	2779	2570	2392	2239	2106	1988		

Table 20b

STRAMIT CONDECK HP® DECKING – Positive FER Minimum Cross Sectional Area Required (mm²) Fire resistance period – 120 minutes															
+ve	Slab Depth (mm)														
Moment ⁺	120	125	130	140	150	160	170	180	190	200	210	220	230	240	250
0	0	0	0	0	0	0	0	0	0	0	0	0	0	0	0
2	102	95	89	78	70	64	58	54	50	46	43	41	39	36	35
4	207	192	179	158	142	128	117	108	100	93	87	82	77	73	69
6	315	291	272	239	214	193	176	162	150	140	131	123	116	110	104
8	426	394	366	321	287	259	236	217	201	187	175	164	155	147	139
10	541	498	463	405	361	326	297	273	252	235	219	206	194	184	174
12	659	606	562	490	436	393	358	328	304	282	264	248	234	221	209
14	782	717	663	577	512	461	419	384	355	330	309	290	273	258	245
16	911	832	767	666	590	530	481	441	407	379	354	332	313	295	280
18	1044	951	875	756	668	599	544	498	460	427	399	374	352	333	316
20	1184	1074	985	849	748	670	607	556	513	476	444	417	392	371	351
22	1332	1202	1099	943	829	741	671	614	566	525	490	459	432	408	387
24		1336	1217	1039	912	814	736	672	619	575	536	502	473	446	423
26			1339	1138	995	887	801	732	673	624	582	545	513	484	459
28			1466	1240	1081	961	867	791	728	674	628	588	553	523	495
30				1344	1168	1037	934	851	783	725	675	632	594	561	531
32				1451	1257	1113	1002	912	838	775	722	676	635	599	567
34				1561	1347	1191	1070	973	893	826	769	720	676	638	604
36				1675	1440	1270	1139	1035	949	878	817	764	717	677	640
38					1534	1350	1209	1098	1006	929	864	808	759	716	677
40					1631	1431	1280	1161	1063	981	912	853	801	755	714
42					1730	1514	1352	1224	1120	1034	960	897	842	794	751
44					1832	1598	1425	1289	1178	1087	1009	942	884	833	788
46					1936	1684	1498	1354	1237	1140	1058	988	926	873	825
48						1772	1573	1419	1296	1193	1107	1033	969	912	862
50						1861	1649	1486	1355	1247	1156	1079	1011	952	900
52						1952	1726	1553	1415	1302	1206	1125	1054	992	938
54						2045	1804	1621	1476	1356	1256	1171	1097	1032	975
56							1883	1690	1537	1411	1307	1217	1140	1073	1013
58							1964	1760	1598	1467	1357	1264	1183	1113	1051
60															

FER Mesh Reduction

The ribs of **Stramit Condeck HP®** Decking are fully embedded within the finished slab. It has been shown that these ribs retain most of their strength even during fire exposure of up to two hours. This residual strength of the ribs can be used to reduce the quantity of bottom Fire Emergency Reinforcement (FER) mesh used in fire design.

Table 21

STRAMIT CONDECK HP® DECKING – Reduction in FER mesh used in fire design			
A_{st}^m (mm²/m)			
FRP (minutes)	thickness (mm)/mesh steel grade		
	0.75 500N	0.90 500N	1.00 500N
60	273	320	351
90	230	268	292
120	209	242	262

Note: The limiting tensile strain in the top flanges is assumed to be 1.5%.

Design Example

This design example shows the complete design procedure for a **Stramit Condeck HP®** slab through Formwork, Composite and Fire Design sections of this manual, used in conjunction with AS3600.

GENERAL

Slab thickness	= 120mm
Span configuration	3 span continuous
Span lengths (L)	= 3m
Superimposed dead load	= 1kPa
Live load (q)	= 3kPa
Use of building	office
Concrete strength (f'c)	= 25MPa
Support widths	= 100mm
Total deflection limit of slab	= Span/250
FRL	= 120/120/120

FORMWORK MODE

Choose 0.9mm thick **Stramit Condeck HP®** Decking
 Deflection limit in formwork mode = Span/240
 From Table 3c, maximum unpropped span = 2.47m
 Hence propping required
 From Table 3c, for 3m span and 120mm slab, one row of props required

COMPOSITE SLAB MODE

Loads

Weight of slab + deck	= 3.07kPa
Dead load (g)	= 3.07kPa + 1kPa = 4.07kPa
Live load (q)	= 3kPa
From ASI 170.1, Ψ_c	= 0.4
Strength limit state load(F)	= 1.25g + 1.5q = 9.6kPa
Fire limit state load (w_f)	= 1.1g + 0.4q = 5.7kPa

Design

From Table 11b, allowable live load 10kPa
 $q = 3kPa$, hence satisfactory

Redistributed negative moment at support
 = 6.3kNm/m width

Design negative moment at $0.7a_{sup} = 6kNm/m$ width

For moment of 6.0kNm, area of normal ductility bar reinforcement can be determined to be $\approx 161mm^2/m$

Use SL62 shrinkage and temperature mesh = 141mm²/m (placed on deck)

Use SL62 mesh on whole slab and 10mm diameter bars at 240mm centres in negative moment areas (327mm²/m)

Fire Conditions

For the end span, $A_{st}^* = 796mm^2/m$, lever arm = 56.6mm
 Since $A_{st}^* > 327mm^2/m$, 327mm²/m is used in the calculations

Negative moment capacity =

$$0.8 \times 500 \times 327 \times 56.6 \times 10^{-6} = 7.4kNm/m$$

Maximum positive moment from step 8 of the Fire Design procedure

$$M_{neg_1} = 0, M_{neg_2} = 7.4kNm, w_f = 5.7kPa, L = 3m$$

Maximum positive moment = 3.25kNm/m

Approximate positive steel required $\approx 168mm^2/m$

If contribution of decking ribs is to be included, additional steel required = 168 - 242mm²/m

Hence no bars required

For the internal span, $M_{neg_1} = 7.4kNm$, $M_{neg_2} = 7.4kNm$, $w_f = 5.7kPa$, $L = 3m$

Maximum positive moment < 0

No positive reinforcement required

NOTE: If reinforcement is curtailed, strength of this cross section must be checked.

Fire Resistant Sprays

Fire rating for **Stramit Condeck HP®** Composite Slabs can be achieved by spraying the underside of the decking with one of various types of fire protection sprays. If sufficient coating is provided, the composite slab can be designed for ambient conditions.

Please consult fire protection spray manufacturers or suppliers for product type and coating mass/thickness details, and for adhesion suitability.

Fire Resistant Ceilings

Fire rating for **Stramit Condeck HP®** Composite Slabs can be achieved by installing a suitable fire-rated plasterboard ceiling system. If a suitable ceiling is provided, the composite slab can then be designed for ambient conditions.

Procurement

Obtaining Prices

Prices of **Stramit Condeck HP**® Decking and accessories can be obtained from your nearest Stramit location, or distributor of Stramit products.

Components

The **Stramit Condeck HP**® Composite Slab system comprises:-

Stramit Condeck HP® Decking – 0.75mm, 0.90mm OR 1.00mm thick

Stramit Condeck HP Plus™ End Span Accessory – 1.00mm

Stramit Edgeforma™ Slab Edging – 1.00mm (for slabs up to 140mm) OR 1.60mm (for slabs up to 200mm)

Stramit® Two-Part Ceiling Hanger

Lengths

Stramit Condeck HP® Decking can be supplied in any length up to the limit of the local Transport Authority regulations. Where practical nominated lengths should be site measurements rather than plan dimensions. The tolerance on lengths supplied is +/- 5mm. Ensure that the lengths specified are the actual required sheet length, and not the effective spans used in design.

Orders

Stramit Condeck HP® Decking and accessories can be ordered directly from Stramit, or through distributors.

Lead Times

Stramit Condeck HP® Decking is normally supplied within 2 to 3 days of placement of order. Please talk to Stramit about current lead times particularly for large or non-standard orders.

Delivery/Unloading

Lead times are subject to location and quantity. Please talk to Stramit about delivery scheduling for large projects. Ensure that suitable arrangements have been made for truck unloading, as this is the responsibility of the receiver. Pack mass may be up to one tonne.

Site Storage

It is recommended that sheets be placed as soon as possible after delivery. If site storage is necessary packs should be kept dry and above ground. If sheets do become wet they should be separated, wiped and placed in the open to promote drying.

Installation

The sub-headings within this Installation section are indicative of the sequence of installation.

Good Practice

Stramit recommends that good trade practice be followed when using these products, such as found in CCAA/Standards Australia handbook HB67 'Concrete practice on building sites'.

Supports

It is imperative that permanent supports (steel or concrete beams, or walls) be stable and of adequate strength to withstand loadings prior to the placement of the decking. Ensure that the end bearing width (min 50mm) and internal bearing width (min 100mm) nominated by the engineer is achieved on site.

In the case of masonry walls, a damp-course strip should be installed between the masonry and the decking.

Walking

Take care when walking on **Stramit Condeck HP**® Decking, particularly if the surface has become wet. Wear suitable rubber-soled footwear at all times. Also note that, when first delivered, there may be traces of rolling oil present. It is possible to step either in the pans or on the ribs of **Stramit Condeck HP**® Decking but when walking use only the pans. Avoid walking on the edge sheet, or on rib ends.

Cutting

Stramit Condeck HP® Decking is supplied cut to length so that cutting is generally only required around projections and cut-outs. Use a power saw fitted with an abrasive disc or metal cutting blade.

It is recommended that cuts be started with the decking laid upside down (ribs down). Then turn the sheet and, if necessary, complete the cutting of the ribs. This method should provide the neatest finish, and minimise the risk of burred edges being exposed on the finished slab.

Temporary Propping

Temporary propping, where required, must provide continuous transverse (across the sheet) support at the prescribed spacings. The prop bearer width must be no less than 100mm, unless established by calculation.

Continuous support is generally provided by substantial timber or steel beams supported by vertical props. If the deck soffit is to be left exposed, it is recommended that a piece of caneite or similar be placed between the bearer and the deck. All propping should meet the requirements of AS3610, including bracing. Prop bearers should not be placed higher than the permanent end support.

Decking Placement

Stramit Condeck HP® Decking is easily placed by hinging the overlap edge of one sheet over the underlap edge of the previous sheet. If the decking is used as a platform for laying subsequent sheets, designated propping must be positioned first.

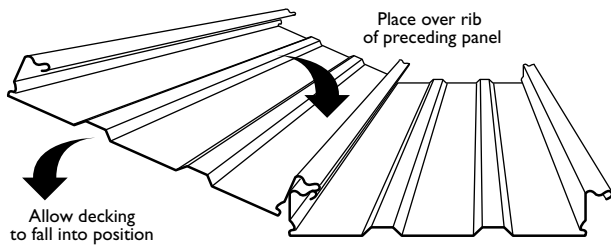

Fixing

Once decking panels are laid they should immediately be secured against possible wind uplift. Typically use one fixing per pan at end supports, and one fixing every third pan at permanent internal supports. Self-drilling and tapping screws or powder actuated drive pins are commonly used. These fixings should be adjacent to the decking ribs. In exposed conditions additional fixing may be required. Shear studs, if used, attached immediately after decking placement, or puddle welds, will provide wind uplift resistance.

Side-Lap Fastening

Side-lap fastening is only required if stacked construction materials are to be laid on the decking. Where required, side-lap fasteners should be at least No.10x16 self-drilling and tapping screws. These should be fixed through the trough in the rib tops, and positioned at mid span on every rib.

Slab Edges

The edge of **Stramit Condeck HP®** Composite Slabs may be addressed in a number of different ways. The illustrations below show the alternatives:

IMPORTANT!

It is essential that the slab and its supports are fixed or keyed together to avoid relative movement, for example due to earthquakes. This is particularly important where precast supports are used

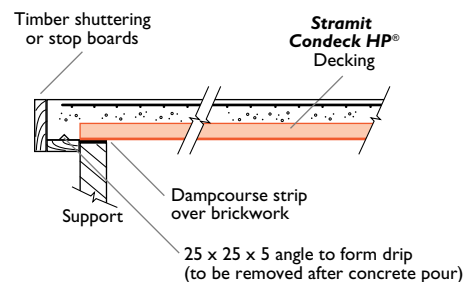
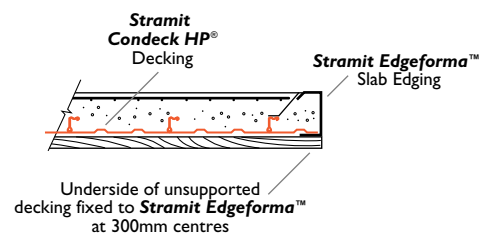
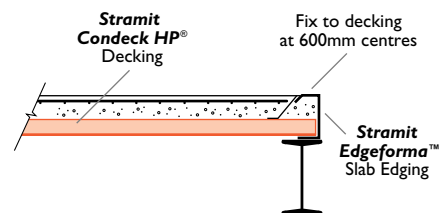
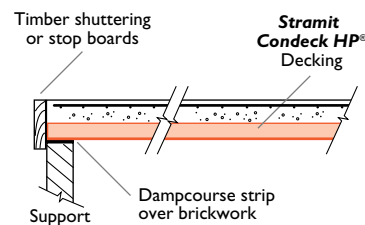
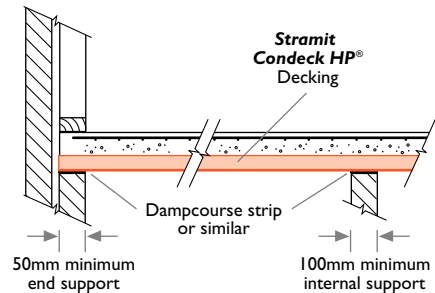
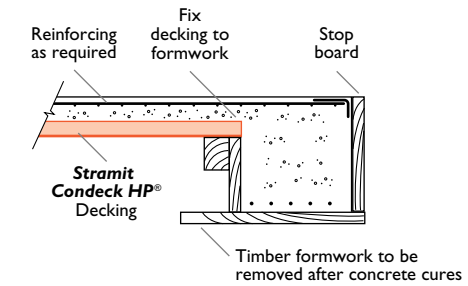
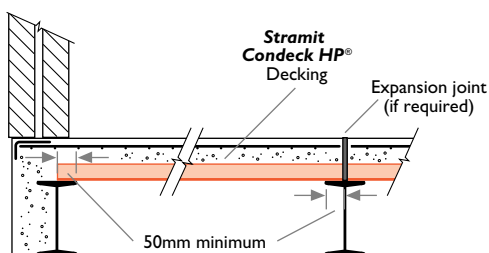

NOTE

Edges of metal deck slabs exposed to direct or indirect rainfall must have a continuous drip feature to prevent water running to the underside of the decking. This is typically achieved by incorporating a formed notch in an all-concrete edge strip overhanging the supports.

Wall Abutments

Slabs adjacent to walls can also be treated by alternative means, such as those shown below.

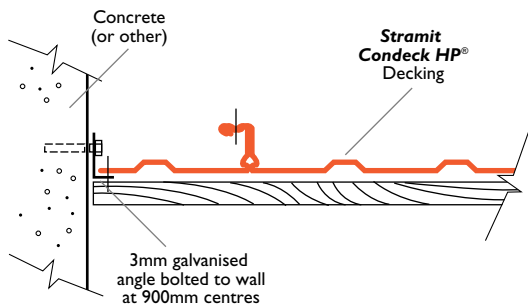
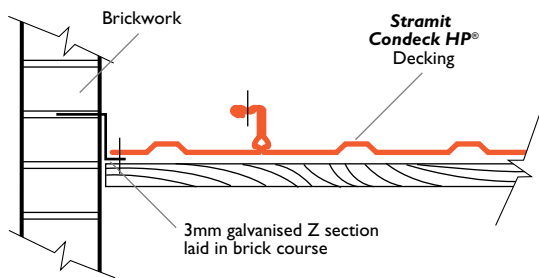
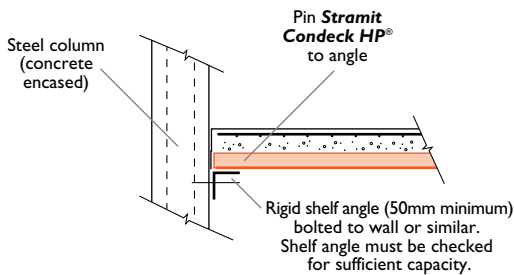
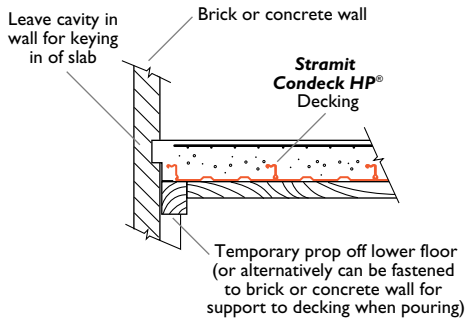

INTERNAL PRE-CAST WALL ABUTMENT

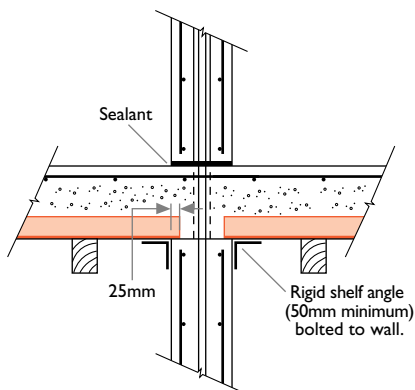

NOTES: 1. Standard end bearing of **Stramit Condeck HP** Decking is 50mm.
2. For 25mm end bearing, end of sheets should be fastened to support.

Large Slab Penetrations

Floor penetrations can be conveniently formed by conventional formwork methods and then cut out after the concrete has set. The reinforcing shown is required for penetrations of 200mm to 750mm. For large predetermined openings greater than 750mm, such as for stairs, elevators, etc. the most practical method generally is to supply supplemental structural framing to the support system for the **Stramit Condeck HP** Decking.

The cross sectional area of reinforcement around the opening equals the area of mesh reinforcement "lost" in the opening.

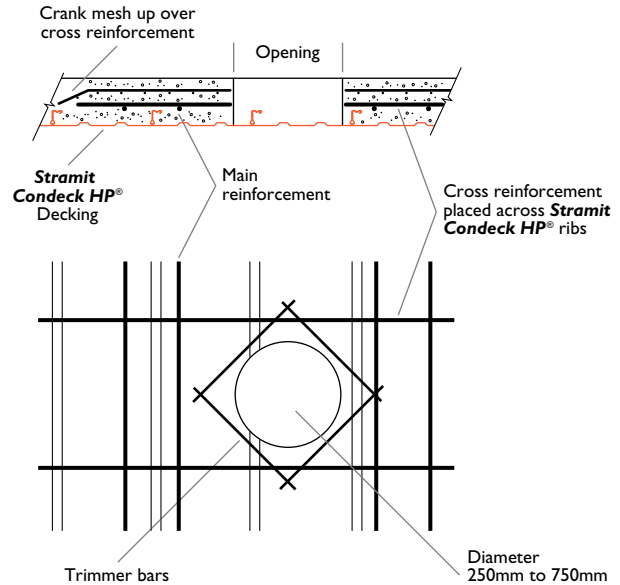

Any decking containing penetrations where the total penetration exceeds 200mm must be assumed to be non-continuous, i.e. it must be supported or designed as a cantilever.

Small Slab Penetrations

Holes can be cut through a **Stramit Condeck HP** Slab, but this must be done with caution. The following constraints apply:-

1. Always obtain approval from the design engineer prior to cutting.
2. Do not cut holes through the decking prior to concrete placement and cure.
3. Do not position holes within the negative moment region of a continuous slab (i.e. keep clear of internal supports).
4. Holes must not exceed 200mm diameter, and must be central within the pan of the decking.
5. Holes must be either drilled or sawn using appropriate cutting tools.
6. No other holes/penetrations within 1000mm.

Deck with holes of no greater than 200mm meeting the criteria above can be considered to be continuous.

Stramit Condeck HP Plus™ End Span Accessory

Where required by design, **Stramit Condeck HP Plus™** End Span Accessory is generally used adjacent to every rib in each nominated end span. In fact the accessory is required to be the full length of the end span plus the longer of, an additional 300mm or 10% of the end span length. The additional length protrudes into the adjacent internal span.

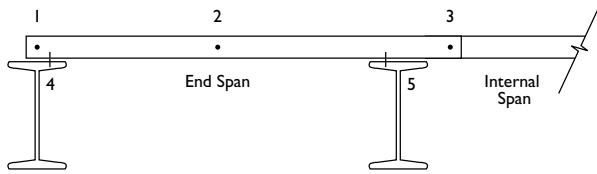

HP Plus must be attached to the deck at the end support (1), at the middle of the end span (2), and at the accessory end within the internal span (3). Fix using at least No.10x16 self-drilling and tapping screws, fastened through the rib sides as shown below. Also fix HP Plus through the decking to both the end (4) and internal support beam (5).

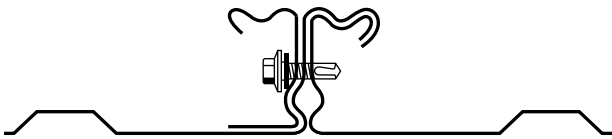

Shear Studs

Welded shear studs may be nominated for use with composite beams. These should be placed into prescribed positions using suitable stud welding guns. Use settings and procedure appropriate for the deck galvanised coating (350g/m² or 450g/m²) and the beam coating/s.

Standard placements for 19mm diameter studs, along with placement rules*, are illustrated below:-

300 SPACING

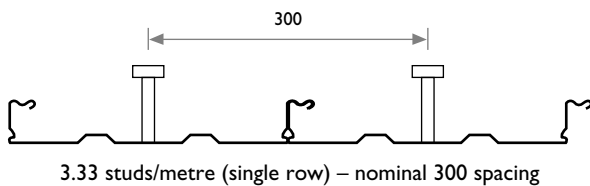

200 SPACING

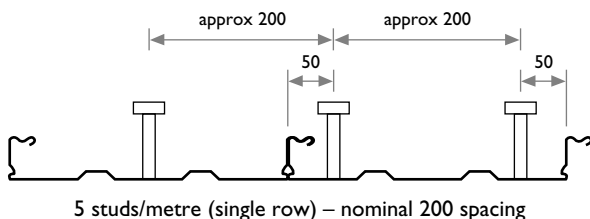

150 SPACING

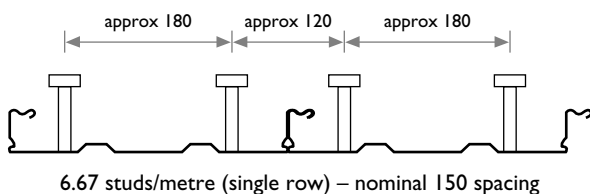

100 SPACING

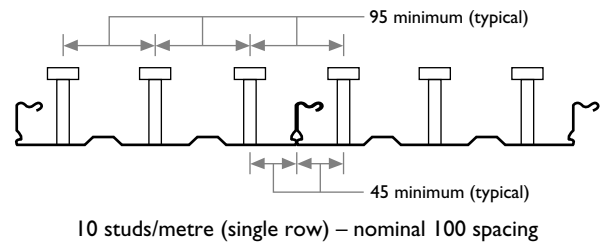

Each of the stud/metre values above can be doubled by using two parallel rows of studs, spaced no less than 95mm apart.

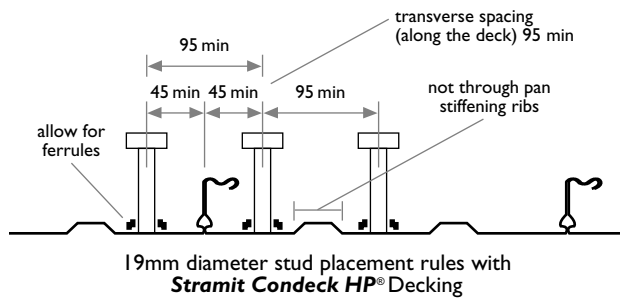

* Placement rules have been established by independent tests and evaluation.

Stacked Materials

Great care must be taken during construction to avoid damage from stacked materials. The formwork mode data given in this manual is based on a maximum stacked material load of 1.5kPa loaded in the pans.

Other loading cases can be determined using the software **Stramit Condeck HP Slab Designer™**. Refer to the engineer or the design drawings for the stacked material allowance used in design, as this is often varied. If in doubt either do not stack materials onto the decking, or contact your Stramit Technical Representative.

Sealing

Stramit Condeck HP® Decking provides resistance to leakage during concrete pouring. For most applications where the concrete slump is not excessive no sealing is required. To prevent slurry leakage (if required) just tape over the small ceiling hanger recess near the bottom of the ribs, and the two pan stiffening rib recesses, at each sheet end.

Mesh Placement

Place the shrinkage and temperature reinforcement (fabric) such that minimum cover requirement as per AS3600 is satisfied (generally 20mm to 30mm cover from top of slab or on top of the deck ribs for thin slabs).

- The fabric shall be properly lapped and tied to ensure continuity in both directions.
- If the slab has been designed as continuous, then additional steel reinforcement as specified by the Engineer shall be provided over supports.

Concrete Pouring

Finally, the concrete must be poured evenly to the panel ends on the prepared clean deck, in the direction of span of the decking. Heaping of wet concrete must be avoided. The concrete should be placed in accordance with the requirements of AS3600 and have a minimum 28 day compressive strength $f'c = 25\text{MPa}$ and slump satisfying the Engineers requirements. As a guide, the slump should be 60mm – 80mm for vibrator compaction. Hand compaction is not recommended.

Admixtures

Chemical admixtures are allowed provided they are in accordance with AS3600.

Concrete Curing

Stramit Condeck HP® Composite Slabs require the same degree of curing as a conventional reinforced concrete slab. Follow the guidelines within AS3610.

Prop Removal

Temporary propping must not be removed until the slab has cured sufficiently. Prop removal procedure should be in accordance with AS3610.

Suspension Hangers

Stramit Condeck HP® Decking has provision for suspended ceiling installation or support of building services. A two part hanger bracket is simply inserted into the underside of any rib and held in place by the suspension rod.

The ceiling hanger is capable of supporting a load of 2.5kN. It is easier to insert the hangers before the concrete pour, although they can be inserted after if required.

NB: Ceiling hanger performance is dependent on concrete being in place. Performance of the ceiling hanger, loaded BEFORE the concrete pour is significantly less. Provided additional side lap fasteners are installed through the vertical web of the ribs – at no more than 500mm centres either side of the hanger, capacity of the hanger is reduced to 0.6kN.

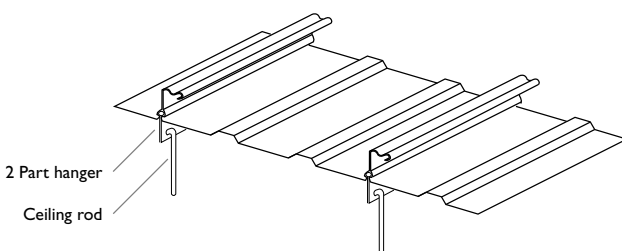

Proprietary post-casting anchors may also be used with **Stramit Condeck HP**® Decking for suspended services.

Additional Information

Technical Assistance

Stramit has experienced engineers and technical staff in each region. For assistance with design issues, composite decking applications and practical advice, contact your regional Technical Services Manager. Alternatively, ring your nearest Stramit location and say you have a technical enquiry regarding **Stramit Condeck HP**® Decking.

Further Information

As well as our standard range of Technical Manuals, Installation Leaflets, Case Studies and other promotional literature Stramit has a series of Guides to aid design. These include:

- Concealed Fixed Decking
- Roof Slope Guide
- Foot Traffic Guide
- Bullnosing, Curving and Crimping
- Acoustic Panels
- Cyclonic Areas
- Spring Curving Guide

Please contact your nearest Stramit location for any of these guides, other literature, or the composite slab design CD-ROM '**Stramit Condeck HP Slab Designer**'™.

Other Products

Stramit offers a wide range of building products, including:

- Lost formwork
- Purlins and girts
- Roof and wall sheeting
- Lightweight structural sections
- Truss components
- Gutters and downpipes
- Fascias
- Custom flashings
- Insulating products
- Fasteners



The Stramit web page can be found at:

www.stramit.com.au

Details of many **Stramit**® products can also be seen on the RAI A site 'Product Selector' at:
www.selector.com.au

Building Products

contact numbers for information

		prices	availability	general	technical
			products coating colours	other	advice product data
SYDNEY 33-83 Quarry Road, Erskine Park NSW 2759	phone fax	(02) 9834 0909 (02) 9834 0988		(02) 9834 0900 (02) 9834 0988	
CANBERRA 4 Bass Street, Queanbeyan NSW 2620	phone fax		(02) 6297 3533 (02) 6297 8089		
COFFS HARBOUR 6 Mansbridge Drive, Coffs Harbour NSW 2450	phone fax		(02) 6652 6333 (02) 6651 3395		(02) 4954 5033 (02) 4954 5856
NEWCASTLE 17 Nelson Road, Cardiff NSW 2285	phone fax		(02) 4954 5033 (02) 4954 5856		
ORANGE 51 Leewood Drive, Orange NSW 2800	phone fax		(02) 6361 0444 (02) 6361 9814		
MELBOURNE 2/1464 Ferntree Gully Road, Knoxfield VIC 3180	phone fax	(03) 9237 6300 (03) 9237 6399		(03) 9237 6200 (03) 9237 6299	
ALBURY 18 Ariel Drive, Albury NSW 2640	phone fax		(02) 6041 7600 (02) 6041 7666		
BENDIGO Ramsay Court, Kangaroo Flat VIC 3555	phone fax		(03) 5447 8455 (03) 5447 9677		
MILDURA 19 - 23 Adams Street, Mildura VIC 3500	phone fax		(03) 5018 4800 (03) 5021 0557		
TASMANIA 57 Crooked Billett Drive, Brighton TAS 7030	phone fax		(03) 6263 5536 (03) 6263 6950		(03) 6263 5536 (03) 6263 6950
ADELAIDE 11 Stock Road, Cavan SA 5094	phone fax		(08) 8262 4444 (08) 8262 6333		(08) 8262 4444 (08) 8262 6333
BRISBANE 57-71 Platinum Street, Crestmead QLD 4132	phone fax		(07) 3803 9999 (07) 3803 1499		
TOWNSVILLE 402-408 Bayswater Road, Garbutt QLD 4814	phone fax		(07) 4779 0844 (07) 4775 7155		
CAIRNS Vickers Street, Edmonton QLD 4869	phone fax		(07) 4045 3069 (07) 4045 4762		
MACKAY Brickworks Court, Glenella QLD 4740	phone fax		(07) 4942 3488 (07) 4942 2343		(07) 3803 9999 (07) 3803 1499
MARYBOROUGH 10 Activity St, Maryborough QLD 4650	phone fax		(07) 4121 2433 (07) 4123 3139		
ROCKHAMPTON 41 Johnson St, Parkhurst QLD 4702	phone fax		(07) 4936 2577 (07) 4936 4603		
DARWIN 55 Albatross Street, Winnellie NT 0820	phone fax		(08) 8947 0780 (08) 8947 1577		
PERTH 605-615 Bickley Road, Maddington WA 6109	phone fax		(08) 9493 8800 (08) 9493 8899		

® Registered trademarks of Stramit Corporation Pty Limited. ABN 57 005 010 195 trading as Stramit Building Products

A member of the Fletcher Building Group

COLORBOND® and ZINCALUME® are registered trademarks of BlueScope Steel Limited

© Stramit Corporation Pty. Limited December 2012.

This document replaces all previous issues. Please destroy, or clearly mark as superseded, all previous issues.