

CURVED CORRUGATED AND BULLNOSE ROOF CLADDING

Product Technical Manual

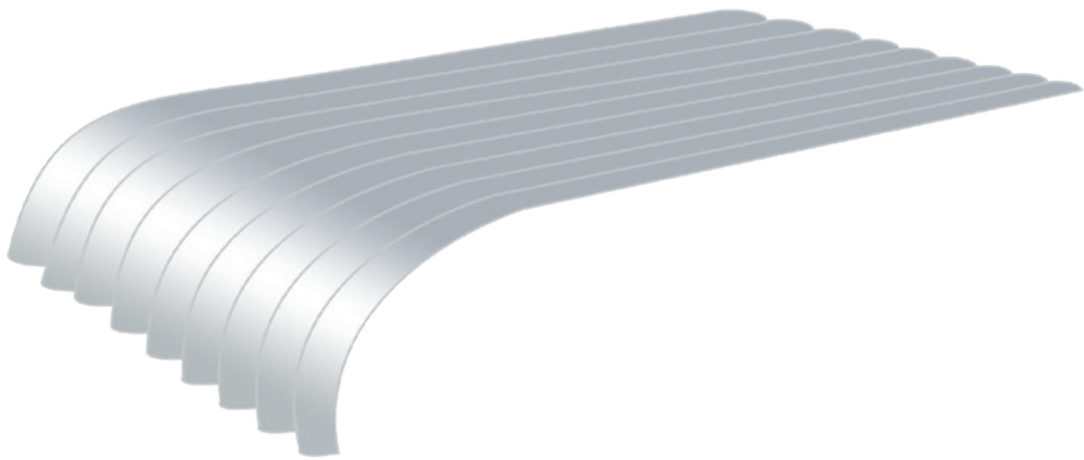

SELECTION AND SPECIFICATION



FEATURES/BENEFITS

- Design flexibility – expands the versatility of traditional corrugated roofing by increasing flexibility of design.
- Variety of shapes – can be formed into a wide variety of curved shapes and radii down to a nominal 500mm minimum.
- Easy fixing – conventional through-fixed screws maximise performance and ease of installation.
- 762mm cover – quick installation and easy handling.
- G300 curving quality base steel – also available as flat sheets to ensure matching profile on end laps.
- Fully tested – full range of load performance tables to suit most applications.

IMPORTANT NOTICE AND DISCLAIMER

The information contained within this brochure is for general use and information only. Before application in a particular situation, Stramit recommends that you obtain appropriate independent qualified expert advice confirming the suitability of product(s) and information in question for the application proposed. While Stramit accepts its legal obligations, be aware however that to the extent permitted by law, Stramit disclaims all liability (including liability for negligence) for all loss and damage resulting from the use of the information provided in this brochure.

APPLICATIONS

Stramit® Curved Corrugated steel roofing can be pre-curved to produce a variety of interesting effects that enhance both modern and traditional building designs. Straight sheets can be combined with convex and concave curves to create highly original and aesthetically pleasing roof shapes.

The heritage bullnose veranda is the best-known application of curved corrugated sheeting but by no means the only one. Stramit® Curved Corrugated roofing is also a popular choice on contemporary steel-roofed homes and commercial buildings.

Stramit® Curved Corrugated cladding is only intended for use in commercial/industrial/residential roof or wall cladding applications. Do not use for any other purpose.

MATERIALS

Stramit® Curved Corrugated cladding is manufactured from G300 colour coated steel, aluminium-zinc-magnesium or zinc-aluminium alloy coated steel. In some locations galvanised and severe environment colour coated steel may be available by arrangement. Colour coated steels are in accordance with AS/NZS2728 – Category 3 and, for the substrate, with AS1397. Aluminium-zinc-magnesium alloy coated AM100/AM125, zinc-aluminium alloy coated AZ150 and galvanised Z450 conform to AS1397.

Stramit has a comprehensive range of colours as standard. Ask your nearest Stramit location for colour availability.

STRAMIT® CURVED CORRUGATED CLADDING - SHEETING MASS (kg/m ² of roof area)				
THICKNESS BMT	GRADE	ZINCALUME®	COLORBOND®	GALVANISED
0.60mm	300MPa	6.02	6.09	6.39

TESTING

Stramit has in-house, purpose built, testing equipment used to design, develop and improve products for the Australian market. In addition many Stramit® products are tested or witnessed by independent organisations. These include:

- Cyclone Testing Station (James Cook University)
- University of Queensland

This ongoing research and development activity ensures that Stramit remains at the forefront of innovation, design and consumer information.

ADVERSE CONDITIONS

Stramit® Curved Corrugated roof and wall cladding will give excellent durability in almost all locations. It is however important to choose the correct coating for each application environment as shown in the table below. Durability recommendations do vary based on the application of the product, in roofing or walling installations. Please read the tables below carefully.

Suitability of coating type	Roof sheeting - site exposure condition			Wall cladding - distance from marine environment
	mild/moderate	severe marine	very severe marine	
Zinc-Aluminium (AZ150)	✓	✗	✗	>1km
ZINCALUME® (AM125)	✓	✗	✗	>1km
COLORBOND®	✓	✗	✗	>1km
COLORBOND® METALLIC	✓	✗	✗	>1km*
COLORBOND® ULTRA	N/A	✓	✗	>500m
COLORBOND® STAINLESS	N/A	N/A	✓	>0m

* >2km residential buildings

The approximate site exposure conditions in the table above are defined below.

Site exposure condition	Roof sheeting - distance of site from	
	breaking surf/exposed marine	calm marine
mild/moderate	>200m	>100m
severe marine	>100m	>0m
very severe marine	>0m	>0m

The suitability and exposure tables above are current at the time of publication and are guidelines only; conditions will vary from site to site. Please check the Bluescope Technical Bulletins at www.bluescopesteel.com.au for the latest information and guidance on selection, maintenance and durability. If uncertain about the appropriate coating for a particular application, or if the product is to be used in environments affected by industrial emissions, fossil fuel combustion, animal farming, or has unwashed areas, please contact your nearest Stramit office for advice.

COMPATIBILITY

All building products need to be checked for compatibility with adjacent materials. These checks need to be for both direct contact between materials, and where water runs from one material to another. The following guidelines generally avoid material incompatibility:

- For zinc-aluminium/aluminium-zinc-magnesium alloy coated steel, colour coated steel and galvanised steel roofs avoid copper, lead, green or treated timber, stainless steel, uncoated steel and mortar or concrete.
- In addition galvanised steel roofs should not receive drainage from aluminium or any inert materials, such as plastics, glass, glazed tiles, colour coated and zinc-aluminium/aluminium-zinc-magnesium alloy. Contact Stramit for more detailed information.

ARCHITECTURAL SPECIFICATION

The roofing/walling shall be 0.60mm BMT Stramit® Corrugated in continuous lengths with sinusoidal curved ribs 16mm high spaced at 76.2mm centres in accordance with AS1445, curved to a radius of _____mm. Sheeting material shall be protected steel sheet to Australian Standard AS1397 with a minimum yield stress of 300MPa (Grade 300) and an AM100/AZ150 coating with an oven-baked paint film of selected colour, or a plain AM125/AZ150 coating. The sheeting shall be fixed to the purlins/girts in accordance with the manufacturer's recommendations. Suitable fixing screws in

accordance with Australian Standard AS3566, Class 3, shall be used at every support with side lap fasteners installed at mid span. Sheets shall be laid in such a manner that the approved side lap faces away from the prevailing weather.

A minimum of 50mm shall be provided for projection into gutters. Flashing shall be supplied in compatible materials as specified; minimum cover of flashing shall be 150mm. All sheeting shall be fixed in a workmanlike manner, leaving the job clean and weather tight. All debris (nuts, screws, cuttings, filling, etc.) shall be cleared off daily.

TYPICAL CURVED PROFILES

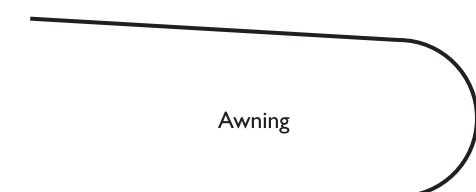
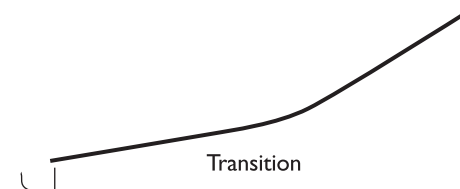
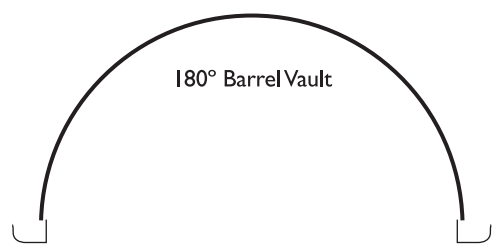
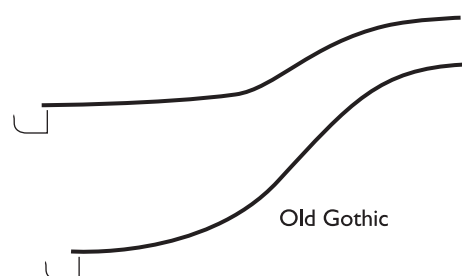
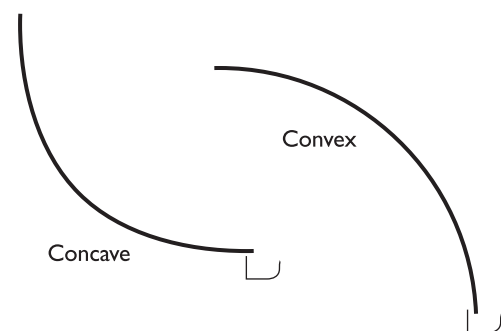
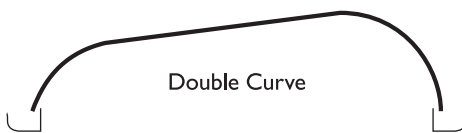
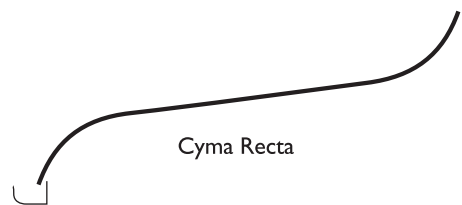
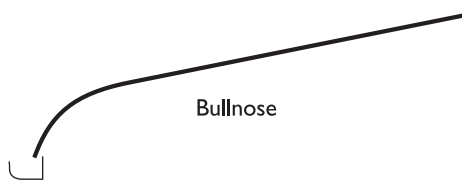

DESIGN

SPANS

The spans shown below take account of 'normal' foot traffic and wind resistance including local pressure zone effects. Pressures are based on AS4055 or AS/NZS1170.2. Where the two standards differ, the worst case has been taken for each classification. Data should only be used for buildings 7m or less in height, 1000m² or less in area, where both length and width exceed the building height and site is unaffected by land

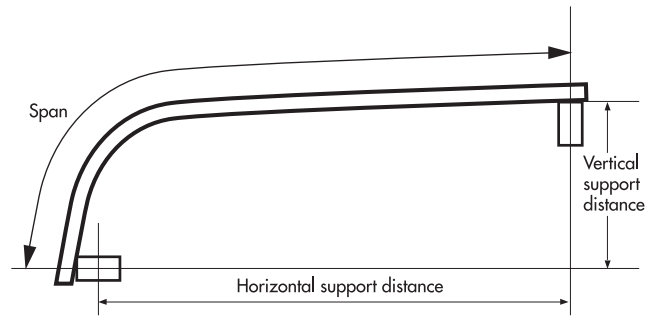

topography. For bullnosed roofs the span is to be taken as the sheet length between fastening positions at supports.

STRAMIT® CURVED CORRUGATED CLADDING - MAXIMUM SPAN CHART (mm)													
bmt (mm)	fasteners per sheet at each support	roofs					walls					overhangs	
		pressure (kPa) service-ability	strength	single spans	double/equal spans	internal (end) span combination	pressure (kPa) service-ability	strength	single spans	double/equal spans	internal (end) span combination	free edge	stiffened edge
N1 or Region A (TC3, FS) Wind Classification													
0.60	3 screws	1.07	1.81	700	900	1200 (1000)	0.55	0.94	1850	2650	2700 (2250)	100	250
	5 screws	1.07	1.81	700	900	1200 (1000)	0.55	0.94	1900	2600	3000 (2500)	100	250
N2 or Region B (TC3, FS) or Region A (TC2.5, PS) Wind Classification													
0.60	3 screws	1.53	2.53	700	900	1200 (1000)	0.79	1.31	1650	2300	2400 (2000)	100	200
	5 screws	1.53	2.53	700	900	1200 (1000)	0.79	1.31	1650	2250	2700 (2250)	100	200
N3 or Region B (TC2.5, PS) or Region A (TC2, NS) Wind Classification													
0.60	3 screws	1.92	3.92	700	900	1200 (1000)	0.99	2.03	1500	2100	2150 (1750)	50	150
	5 screws	1.92	3.92	700	900	1200 (1000)	0.99	2.03	1550	2000	2400 (2000)	50	150

Internal spans must have both end spans 20% shorter.

TC - Terrain category. FS, PS, NS - Full, partial and no shielding. Internal pressure coefficient +0.2/-0.3.

Values are only valid for use with steel members of 1.5mm or thicker. Where thinner supports are used, fastener capacity must be checked. Refer to Stramit® Top Hat & Battens Product Technical Manual for more information.

For more specific applications Stramit® Curved Corrugated cladding must be designed to the pressure and foot traffic limitations below.

Roof spans may exceed those shown in this table provided the wind pressure and foot traffic limits are not exceeded.

PRESSURES

STRAMIT® CURVED CORRUGATED CLADDING - SERVICEABILITY LIMIT STATE CAPACITY											
thickness bmt (mm)	fasteners per sheet at each support	span type	pressure (kPa) at the spans (mm) shown								
			600	900	1200	1500	1800	2100	2400	2700	3000
0.60	3	internal	4.76	3.57	2.63	1.95	1.46	1.08	0.79	0.55	0.36
		equal	4.45	3.33	2.36	1.83	1.27	1.01	0.74	0.52	0.34
		double	4.45	3.33	2.36	1.83	1.27	1.01	0.74	0.52	0.34
		single	2.80	2.41	1.73	1.03	0.61	0.37	0.25	0.20	
	5	internal	9.54	6.39	3.81	2.54	1.81	1.34	1.02	0.79	0.62
		equal	9.54	4.61	2.74	1.81	1.27	0.92	0.68	0.51	0.38
		double	9.54	4.61	2.74	1.81	1.27	0.92	0.68	0.51	0.38
		single	6.84	5.31	2.18	1.09	0.63	0.41	0.31	0.25	0.23

STRAMIT® CURVED CORRUGATED CLADDING - STRENGTH LIMIT STATE CAPACITY (NON-CYCLONIC)											
thickness bmt (mm)	fasteners per sheet at each support	span type	pressure (kPa) at the spans (mm) shown								
			600	900	1200	1500	1800	2100	2400	2700	3000
0.60	3	internal	12.43	9.93	9.53	8.71	7.58	6.46	5.35	4.33	3.41
		equal	10.20	8.88	8.14	6.90	5.70	4.51	3.44	2.50	1.67
		double	12.00	10.40	9.58	8.19	6.70	5.30	4.05	2.94	1.96
		single	10.36	10.36	9.17	8.01	6.71	5.55	4.60	3.81	3.14
	5	internal	12.43	12.43	12.43	11.42	9.69	8.03	6.50	5.11	3.66
		equal	11.49	11.49	11.49	10.44	8.54	6.76	5.16	3.75	2.50
		double	11.49	11.49	11.49	11.49	10.05	7.95	6.07	4.41	2.95
		single	12.43	10.36	9.17	8.01	6.91	5.93	5.07	4.32	3.66

Tables are based on testing to AS1562.1 and AS4040 parts 0 and 2. Internal spans must have both end spans 20% shorter.

Values only valid for use with steel support members of 1.5mm or thicker. Where thinner supports are used, fastener capacity must be checked.

Refer to Stramit® Cyclonic Areas Roof and Wall Cladding Brochure for information on use in Cyclonic Regions.

FOOT TRAFFIC

Foot traffic limits for Stramit® Curved Corrugated cladding are shown for three alternate foot traffic categories. These are:

- High Maintenance – for applications with repeated maintenance, particularly where personnel may be unfamiliar with correct procedures for walking on metal roofs.
- Normal – based on traditional expectations, with moderate maintenance foot traffic using designated foot paths.
- Controlled – spans that conform to AS1562.1 with 1.1kN load specified in AS/NZS1170.1 for R2 – Other Roofs. These require minimal careful foot traffic only on the designated foot path. Suggested for use only where occasional aesthetic imperfections from foot traffic are acceptable.

STRAMIT® CURVED CORRUGATED CLADDING - FOOT TRAFFIC LIMITED SPANS (mm)				
thickness bmt	span type	foot traffic limits		
		heavy	normal	controlled
0.60	internal	-	1200	1900
	equal	-	900	1600
	double	-	900	1600
	single	-	700	900

Tables are based on tests to AS1562.1 and AS4040 parts 0 and 1.

For more information on foot traffic performance of Stramit® Curved Corrugated cladding and other Stramit® roofing profiles refer to Stramit's Foot Traffic Guide.

SPRING CURVING

Stramit® Curved Corrugated cladding can be spring curved, concave and convex, including curved ridges, provided it is sealed at the apex, and within the recommended limits below:

STRAMIT® CURVED CORRUGATED CLADDING - SPRING-CURVED RADII LIMITS (m)					
bmt (mm)	performance restricted		restricted by drainage at the rainfall intensities shown		
	minimum* radius	lowest neutral radius	370 mm/hr	220 mm/hr	150 mm/hr
0.60	8*	26	37	63	92

*At these radii a maximum support spacing of 900mm applies, and limit state pressure capacities are reduced by 14% for serviceability and 7% for strength. These reductions apply proportionately up to the lowest neutral radius. Minimum 5 fasteners required per sheet at ends.

For more comprehensive information on spring curving Stramit® Curved Corrugated cladding and other Stramit® roofing curved profiles refer to the Stramit Design Guide 'Spring Curving'.

THERMAL EXPANSION

All metal roof sheeting is subject to thermal expansion and, where there is a temperature difference between the sheeting and the structure, this needs to be accommodated. The colour of the sheeting will affect the amount of thermal expansion, and whether the sheet is flat or curved will affect its ability to resist without problems.

Sheet lengths should be limited to those shown below.

STRAMIT® CURVED CORRUGATED CLADDING - MAXIMUM SHEET LENGTH (m)		
roof colour	light	dark
flat	25	17
spring-curved	20	17

WATER CARRYING

Stramit® Curved Corrugated cladding has limited water-carrying capacity. Roof slopes can be as low as 5° for many applications. Roof run lengths are the combined lengths of all roof elements contributing to a single pan drainage path. This can include the roof length upstream of a roof penetration that concentrates flow into other pans. The table below gives slopes for 100 year return period rainfall intensity.

STRAMIT® CURVED CORRUGATED CLADDING - MINIMUM ROOF SLOPE (degrees)									
rainfall intensity mm/hr	total roof run length (m)								max roof run length (m) at min slope
	10	15	20	25	30	35	40	45	
150			5.0	6.5	9.5	13.5	18.0		27
175	<i>Minimum</i>		5.0	6.0	9.5	14.0			23
200	<i>slope 5°</i>		5.0	8.5	13.5				20
225		5.0	6.5	11.5	18.0				18
250		5.0	8.5	15.0					16
275		5.0	11.0	19.0					15
300	5.0	6.5	13.5						13
325	5.0	8.0	16.5						12
350	5.0	9.5							11
375	5.0	11.5							11
400	5.0	13.5							10

Based on AS1562.1

For more information on water carrying performance of Stramit® Curved Corrugated cladding and other Stramit® roofing profiles refer to Stramit's Roof Slope Guide.

DARWIN AREA

Information on the use of Stramit® Curved Corrugated roofing in the Darwin area can be found in deemed-to-comply sheet number M/177/01. This is available from Stramit or the Darwin Area Deemed To Comply Manual.

PROCUREMENT

PRICES

Prices on Stramit® Curved Corrugated cladding and its accessories can be obtained from your nearest Stramit location or distributor of Stramit® products. As Stramit does not provide an installation service, ask your tradesperson for a supply and fix price. Contact your nearest Stramit location for the names of tradespersons in your area.

BULLNOSING/CURVING INFORMATION

To ensure that you receive product to suit your application it is essential that detailed information be supplied.

Please supply template & all information wherever possible.

For curving purposes it is necessary to produce a sheet with a minimum straight section at the sheet end (A) of 100mm. All or part of this straight section can be removed upon request (docked).

BULLNOSING

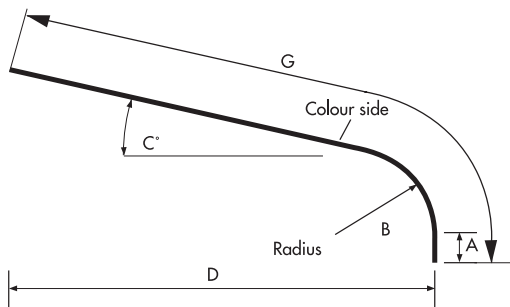

- A** Straight section into gutter _____ mm
- B** Radius of curve _____ mm
- C** Angle of roof pitch _____ degrees
- D** Wall to fascia _____ mm
(Required if **G** not available)
- G** Sheet length _____ mm
(Required if **D** not available)
- Number of sheets required _____
- Direction of laying (left to right/right to left) _____
- Colour _____
- Other curving information (eg. docking, endlapping)

CURVING

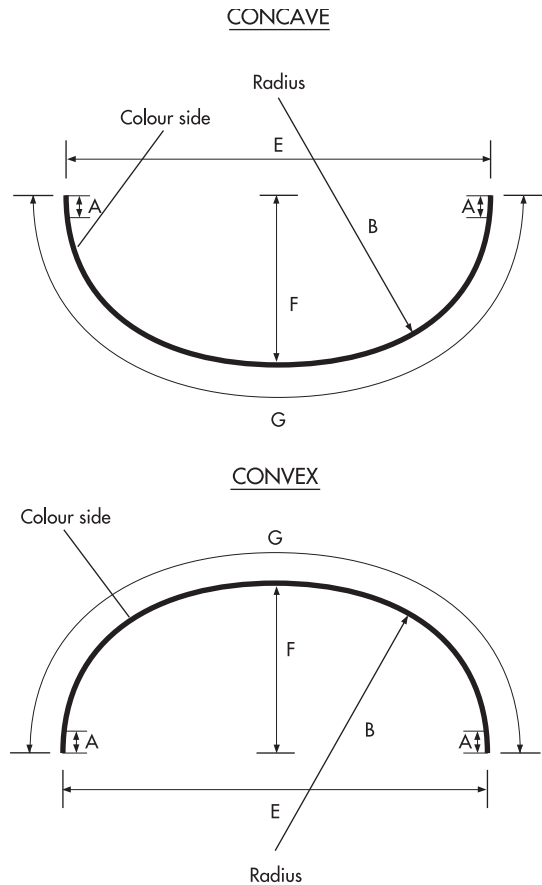

CONCAVE & CONVEX CURVES

- A** Straight section at overhangs _____ mm
- E** Wall to fascia _____ mm
- F** Height _____ mm (Required if **B** not available)
- G** Total sheet length _____ mm
- B** Radius _____ mm (Required if **F** not available)

Type of curve (concave/convex) _____
 Number of sheets required _____
 Colour _____
 Other information (eg. docking, endlapping) _____

RELATED PRODUCTS

Fibreglass Flashing



LENGTH

Stramit® Curved Corrugated can be supplied in any length from 500mm to 4000mm. Longer lengths may be supplied by arrangement. When measuring it should be noted that at the end of each curve adjacent to the curve there is at least 100mm that cannot be curved which must be allowed for. The manufacturing tolerance on the length of products supplied is +0, -15mm.

ORDERING

Minimum radii may vary depending on your Stramit Building Products production centre. A call to your local Stramit office is recommended when planning to use Stramit® Curved Corrugated. When ordering Stramit® Curved Corrugated always provide a template that describes the desired curve. If you require both curved and straight product that will be end lapped, always order products at the same time and inform Stramit of the application. This will ensure that both straight and curved material are of a compatible profile. Always use G300 material for straight sheets to ensure matching profiles. For lengths exceeding 4 metres please contact your local Stramit office.

DELIVERY/UNLOADING

Delivery can normally be made within 48 hours, subject to the delivery location, quantity and material availability, or can be at a pre-arranged date and time. Please ensure that suitable arrangements have been made for truck unloading, as this is the responsibility of the receiver.

Pack mass may be up to one tonne. When lifting Stramit® Curved Corrugated cladding, care should be taken to ensure that the load is spread to prevent damage. Packs must never be placed onto unclad purlin battens except directly above support frames.

HANDLING/STORAGE

Stramit® Curved Corrugated cladding should be handled with care at all times to preserve the product capabilities and quality of the finish. Packs should always be kept dry and stored above ground level while on site. If the sheets have become wet, they should be separated, wiped and placed in the open to promote drying.

INSTALLATION

FASTENERS

All external fastening screws must conform to AS3566 - Class 3. They are to be hexagon headed and must be used with sealing washers for both roofing and walling. For connecting to purlins and top hats use:

For steel (1.5mm bmt or greater)*



- 12 x 35mm self-drilling and threading screws for crest fixing



- 10 x 16mm self-drilling and threading screws for pan fixing to walls

For timber (F11 or better)



- 12 x 50mm type 17 screws for crest fixing



- 10 x 25mm type 17 screws for pan fixing to walls

Side Laps



- 10 x 16mm self drilling and threading screws, or



- 3.2mm diameter sealed aluminium pop rivets

* For attaching Stramit® Curved Corrugated sheeting to battens of thickness less than 1.5mm bmt, refer to Stramit's Top Hats & Battens - Product Technical Manual.

FASTENER LOCATIONS

Stramit® Curved Corrugated cladding can be fixed with either 3 or 5 fasteners per sheet at each batten/purlin to meet the required performance values, as shown below:

CREST FASTENER LOCATIONS



5 Fasteners per sheet



3 Fasteners per sheet*

VALLEY FASTENER LOCATION (WALLS ONLY)



5 Fasteners per sheet



3 Fasteners per sheet*

* Note that spring curved sheeting may require 5, or more, screws along the lowest support to prevent an uneven edge.

SITE INDUCTION

Consideration should be given to handling and installation issues as part of site induction safety procedures. Specific consideration should be given to pack handling, avoidance of cuts, trips, slips and falls, long sheet handling particularly in windy conditions, sheet cutting procedures and surface temperature on sunny days. Personal Protection Equipment (PPE) should always be used.

INSTALLATION

Stramit® Curved Corrugated cladding is readily installed with or without fibreglass insulation blanket. If practical lay sheets in the opposite direction to prevailing weather.

Installation of Stramit® Curved Corrugated cladding is a straightforward procedure using the following fixing sequence:

- 1) Ensure all purlins are in line and correctly installed and that mesh and blanket (if specified) are in place.
- 2) Position and fix the first sheet ensuring the correct sheet overhangs (minimum 50mm). Ensure that screws are not overtightened.
- 3) Continue to fix subsequent sheets checking that sheet ends at the lower edge are exactly aligned.

It is important that the underlap of one sheet does not protrude beyond the overlap of the next - if this is unavoidable, the underlap must be trimmed locally or water 'drawback' may occur.

- 4) For sheeting that exceeds 4 metres in length straight sheets of 0.6mm Corrugated can be end-lapped with curved sheets to obtain the desired length. It is essential that sheets are laid progressively in runs across the roof, i.e. lay a continuous run of lapped sheets from eave to ridge, then start the next run. This ensures that any pitch variation is contained with one sheet width.

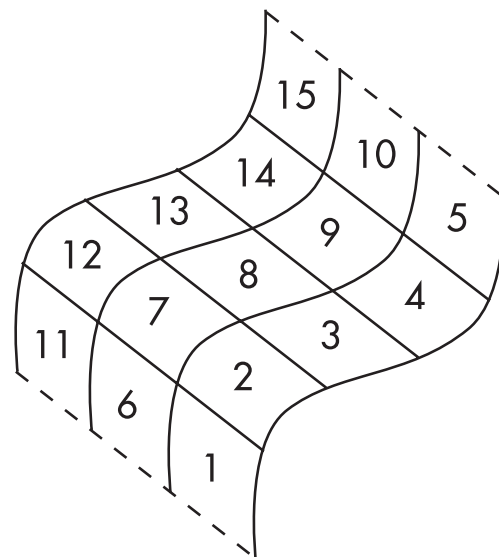

Fix sheets in order shown

Where required, end laps are to be installed in accordance with Standard Australia HB39.

- 5) Measure the overall cover width at top and bottom of the sheets from time to time to avoid 'fanning'.
- 6) For roof spans exceeding 900mm and wall spans exceeding 1200mm, stitch the sidelaps at midspan.
- 7) Turn up the pans at the upper roof edge and install flashings. Fix flashings according to AS1562.1.
- 8) Clean up the roof after each days work, removing all screws, cuttings, swarf etc, and leave roof clean and watertight.

INSULATION

Stramit® Curved Corrugated cladding is suitable for use with insulating blanket. Glasswool blanket up to 50mm thick can be readily used.

Increased thicknesses require longer fasteners and greater care in installation.

For domestic applications Stramit recommends that insulation is always used.

WALKING

As with all roofing products, we recommend extra caution be taken when walking on the roof.

When walking on Stramit® Curved Corrugated cladding roofing always wear flat rubber soled shoes and place feet only on the ribs, taking care to avoid the last rib or two near edges of the metal roof area

Walk only on ribs.

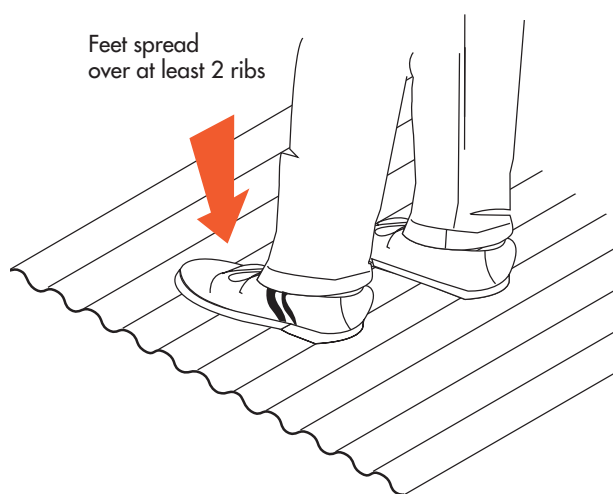

GOOD PRACTICE

Stramit recommends that good trade practice be followed when using this product, such as that found in Australian Standards Handbook HB39.

SHEET HANDLING

Cut resistant or leather gloves should be worn when handling product. Foot protection should be worn when handling and transporting product.

CUTTING

Stramit® Curved Corrugated cladding can be easily cut, where required, using a power saw with a steel cutting blade or a power nibbler and, for localised cutting, tin snips. Avoid the use of abrasive discs as these can cause burred edges and coating damage. Please dispose of any off-cuts carefully.

ADDITIONAL INFORMATION

MAINTENANCE

Exterior surfaces of metal products unwashed by rain can benefit from occasional washing to remove buildup of corrosive salts. Walls beneath eaves or awnings are such a situation.

CLEANING

Should it become necessary to wash Stramit® roof sheeting follow the procedure below.

1. Wash the surface with a mild solution of pure soap or non-abrasive, non-toxic, kitchen detergent in warm water using a sponge, soft cloth or soft bristle nylon brush.
2. Thoroughly rinse the water clean immediately after cleaning.

WARNING - Never use abrasive or solvent type cleaners (e.g. turps, petrol thinners or kerosene) on colour coated steel.

FURTHER INFORMATION

As well as our standard range of Technical Manuals, Installation Leaflets, Case Studies and other promotional literature Stramit has a series of Guides to aid design. These include:

- Concealed Fixed Decking
- Roof Slope Guide
- Foot Traffic Guide
- Acoustic Panels
- Cyclonic Areas
- Spring Curving Guide

Please contact your nearest Stramit location for any of these guides, or other literature.

OTHER PRODUCTS

Stramit offers a wide range of building products including:

- Purlins & Girts
- Formwork decking
- Roof and wall sheeting
- Lightweight structural sections
- Truss components
- Gutters and downpipes
- Fascias
- Custom Flashings
- Insulation products
- Fasteners

REFERENCES

In preparing this document reference has been made to:

- Standards Australia Handbook – HB39
(Installation code for metal roof and wall cladding)
- BlueScope Steel – Technical Bulletin TB-4
(Maintenance of Colorbond prepainted steel roofing)
- BlueScope Steel – Technical Bulletin TB-1
(Steel roofing and walling products – selection guide)

CONTACT US

Visit stramit.com.au or contact us using the details below.

REGION	LOCATION	CONTACT DETAILS	TECHNICAL ENQUIRIES
NSW & ACT	SYDNEY 33-83 Quarry Rd, Erskine Park NSW 2759	Ph 02 9834 0909 Fax 02 9834 0988	Ph 02 9834 0964
	CANBERRA 4 Bass St, Queanbeyan NSW 2620	Ph 02 6298 2500 Fax 02 6298 2533	
	COFFS HARBOUR 6 Mansbridge Dr, Coffs Harbour NSW 2450	Ph 02 6656 3800 Fax 02 6656 3808	
	NEWCASTLE 17 Nelson Rd, Cardiff NSW 2285	Ph 02 4041 3400 Fax 02 4041 3423	
	ORANGE 51 Leewood Dr, Orange NSW 2800	Ph 02 6360 9200 Fax 02 6360 9211	
VIC	MELBOURNE 3/1464 Ferntree Gully Rd, Knoxfield VIC 3180	Ph 03 9237 6300 Fax 03 9237 6399	Ph 03 9237 6353
	ALBURY 18 Ariel Dr, Albury NSW 2640	Ph 02 6092 3700 Fax 02 6092 3766	
	BENDIGO Lot 7-9 Ramsay Court, Kangaroo Flat VIC 3555	Ph 03 5448 6400 Fax 03 5447 9677	
TAS	HOBART 57 Crooked Billett Dr, Brighton TAS 7030	Ph 03 6262 8788 Fax 03 6262 8712	Ph 03 9237 6353
SA	ADELAIDE 11 Stock Rd, Cavan SA 5094	Ph 08 8219 2000 Fax 08 8219 2021	Ph 03 9237 6353
SOUTH QLD	BRISBANE 57-71 Platinum St, Crestmead QLD 4132	Ph 07 3803 9999 Fax 07 3803 1499	Ph 07 3803 9869
	MARYBOROUGH 10 Activity St, Maryborough QLD 4650	Ph 07 4123 9500 Fax 07 4123 9508	
	ROCKHAMPTON 41 Johnson St, Parkhurst QLD 4702	Ph 07 4921 5600 Fax 07 4921 5608	
NORTH QLD	CAIRNS 53 Vickers St, Edmonton QLD 4869	Ph 07 4034 6555 Fax 07 4034 6511	Ph 07 3803 9869
	TOWNSVILLE 402-408 Bayswater Rd, Garbutt QLD 4814	Ph 07 4412 3900 Fax 07 4412 3909	
	MACKAY 6 Brickworks Court, Glenella QLD 4740	Ph 07 4965 4000 Fax 07 4965 4012	
NT	DARWIN 55 Albatross St, Winnellie NT 0820	Ph 08 7922 4600 Fax 08 7922 4608	Ph 07 3803 9869
WA	PERTH 605-615 Bickley Rd, Maddington WA 6109	Ph 08 9493 8800 Fax 08 9493 8899	Ph 07 3803 9869

© 2020 Stramit Corporation Pty Limited ABN 57 005 010 195. A member of the Fletcher Building Group. Use of ™ and * indicates trade marks of Stramit Corporation Pty Limited. COLORBOND® and ZINCALUME® are registered trademarks of Bluescope Steel Limited. This document replaces all previous issues. Please destroy, or clearly mark as superseded, all previous issues. STR038_JUN20.